

## SECTION 11B: DIGITAL TELEVISION

## RECOMMENDATION ITU-R BT.601-5

**STUDIO ENCODING PARAMETERS OF DIGITAL TELEVISION FOR STANDARD 4:3  
AND WIDE-SCREEN 16:9 ASPECT RATIOS**

(Question ITU-R 206/11)

(1982-1986-1990-1992-1994-1995)

The ITU Radiocommunication Assembly,

*considering*

- a) that there are clear advantages for television broadcasters and programme producers in digital studio standards which have the greatest number of significant parameter values common to 525-line and 625-line systems;
- b) that a worldwide compatible digital approach will permit the development of equipment with many common features, permit operating economies and facilitate the international exchange of programmes;
- c) that an extensible family of compatible digital coding standards is desirable. Members of such a family could correspond to different quality levels, different aspect ratios, facilitate additional processing required by present production techniques, and cater for future needs;
- d) that a system based on the coding of components is able to meet these desirable objectives;
- e) that the co-siting of samples representing luminance and colour-difference signals (or, if used, the red, green and blue signals) facilitates the processing of digital component signals, required by present production techniques,

*recommends*

that the following be used as a basis for digital coding standards for television studios in countries using the 525-line system as well as in those using the 625-line system:

## **1 Introduction**

This Recommendation specifies methods for digitally coding video signals. It includes a 13.5 MHz sampling rate for both 4:3 and 16:9 aspect ratios with performance adequate for present transmission systems. An alternative 18 MHz sampling rate for those 16:9 systems which require proportionately higher horizontal resolution is also specified.

Specifications applicable to any member of this family of standards are presented first. Then follows in Part A the specific characteristics for 13.5 MHz sampling and in Part B the specific characteristics for 18 MHz sampling.

## **2 Extensible family of compatible digital coding standards**

**2.1** The digital coding should allow the establishment and evolution of an extensible family of compatible digital coding standards. It should be possible to interface simply between any two members of the family.

**2.2** The digital coding should be based on the use of one luminance and two colour-difference signals (or, if used, the red, green and blue signals).

**2.3** The spectral characteristics of the signals must be controlled to avoid aliasing whilst preserving the passband response. Filter specifications are shown in Appendix 2 to Part A and Appendix 2 to Part B.

### 3 Specifications applicable to any member of the family

**3.1** Sampling structures should be spatially static. This is the case, for example, for the orthogonal sampling structures specified in Part A and Part B.

**3.2** If the samples represent luminance and two simultaneous colour-difference signals, each pair of colour-difference samples should be spatially co-sited. If samples representing red, green and blue signals are used they should be co-sited.

**3.3** The digital standard adopted for each member of the family should permit worldwide acceptance and application in operation; one condition to achieve this goal is that, for each member of the family, the number of samples per line specified for 525-line and 625-line systems shall be compatible (preferably the same number of samples per line).

**3.4** In applications of these specifications, the contents of digital words are expressed in both decimal and hexadecimal forms, denoted by the suffixes “d” and “h” respectively.

To avoid confusion between 8-bit and 10-bit representations, the eight most-significant bits are considered to be an integer part while the two additional bits, if present, are considered to be fractional parts.

For example, the bit pattern 10010001 would be expressed as 145<sub>d</sub> or 91<sub>h</sub>, whereas the pattern 1001000101 would be expressed as 145.25<sub>d</sub> or 91.4<sub>h</sub>.

Where no fractional part is shown, it should be assumed to have the binary value 00.

### 3.5 Definition of the digital signals $Y$ , $C_R$ , $C_B$ , from the primary (analogue) signals $E'_R$ , $E'_G$ and $E'_B$

This section describes, with a view to defining the signals  $Y$ ,  $C_R$ ,  $C_B$ , the rules for construction of these signals from the primary analogue signals  $E'_R$ ,  $E'_G$  and  $E'_B$ . The signals are constructed by following the three stages described in § 3.5.1, 3.5.2 and 3.5.3. The method is given as an example, and in practice other methods of construction from these primary signals or other analogue or digital signals may produce identical results. An example is given in § 3.5.4.

#### 3.5.1 Construction of luminance ( $E'_Y$ ) and colour-difference ( $E'_R - E'_Y$ ) and ( $E'_B - E'_Y$ ) signals

The construction of luminance and colour-difference signals is as follows:

$$E'_Y = 0.299 E'_R + 0.587 E'_G + 0.114 E'_B$$

whence:

$$\begin{aligned} (E'_R - E'_Y) &= E'_R - 0.299 E'_R - 0.587 E'_G - 0.114 E'_B \\ &= 0.701 E'_R - 0.587 E'_G - 0.114 E'_B \end{aligned}$$

and:

$$\begin{aligned} (E'_B - E'_Y) &= E'_B - 0.299 E'_R - 0.587 E'_G - 0.114 E'_B \\ &= -0.299 E'_R - 0.587 E'_G + 0.886 E'_B \end{aligned}$$

Taking the signal values as normalized to unity (e.g. 1.0 V maximum levels), the values obtained for white, black and the saturated primary and complementary colours are shown in Table 1.

TABLE 1  
Normalized signal values

Condition	$E'_R$	$E'_G$	$E'_B$	$E'_Y$	$E'_R - E'_Y$	$E'_B - E'_Y$
White	1.0	1.0	1.0	1.0	0	0
Black	0	0	0	0	0	0
Red	1.0	0	0	0.299	0.701	-0.299
Green	0	1.0	0	0.587	-0.587	-0.587
Blue	0	0	1.0	0.114	-0.114	0.886
Yellow	1.0	1.0	0	0.886	0.114	-0.886
Cyan	0	1.0	1.0	0.701	-0.701	0.299
Magenta	1.0	0	1.0	0.413	0.587	0.587

### 3.5.2 Construction of re-normalized colour-difference signals ( $E'_{C_R}$ and $E'_{C_B}$ )

Whilst the values for  $E'_Y$  have a range of 1.0 to 0, those for  $(E'_R - E'_Y)$  have a range of +0.701 to -0.701 and for  $(E'_B - E'_Y)$  a range of +0.886 to -0.886. To restore the signal excursion of the colour-difference signals to unity (i.e. +0.5 to -0.5), coefficients can be calculated as follows:

$$K_R = \frac{0.5}{0.701} = 0.713; \quad K_B = \frac{0.5}{0.886} = 0.564$$

Then:

$$E'_{C_R} = 0.713 (E'_R - E'_Y) = 0.500 E'_R - 0.419 E'_G - 0.081 E'_B$$

and:

$$E'_{C_B} = 0.564 (E'_B - E'_Y) = -0.169 E'_R - 0.331 E'_G + 0.500 E'_B$$

where  $E'_{C_R}$  and  $E'_{C_B}$  are the re-normalized red and blue colour-difference signals respectively (see Notes 1 and 2).

NOTE 1 – The symbols  $E'_{C_R}$  and  $E'_{C_B}$  will be used only to designate re-normalized colour-difference signals, i.e. having the same nominal peak-to-peak amplitude as the luminance signal  $E'_Y$  thus selected as the reference amplitude.

NOTE 2 – In the circumstances when the component signals are not normalized to a range of 1 to 0, for example, when converting from analogue component signals with unequal luminance and colour-difference amplitudes, an additional gain factor will be necessary and the gain factors  $K_R$ ,  $K_B$  should be modified accordingly.

### 3.5.3 Quantization

In the case of a uniformly-quantized 8-bit binary encoding,  $2^8$ , i.e. 256, equally spaced quantization levels are specified, so that the range of the binary numbers available is from 0000 0000 to 1111 1111 (00 to FF in hexadecimal notation), the equivalent decimal numbers being 0 to 255, inclusive.

In the case of the 4:2:2 systems described in this Recommendation, levels 0 and 255 are reserved for synchronization data, while levels 1 to 254 are available for video.

Given that the luminance signal is to occupy only 220 levels, to provide working margins, and that black is to be at level 16, the decimal value of the luminance signal,  $\bar{Y}$ , prior to quantization, is:

$$\bar{Y} = 219 (E'_Y) + 16$$

and the corresponding level number after quantization is the nearest integer value.

Similarly, given that the colour-difference signals are to occupy 225 levels and that the zero level is to be level 128, the decimal values of the colour-difference signals,  $\bar{C}_R$  and  $\bar{C}_B$ , prior to quantization are:

$$\bar{C}_R = 224 [0.713 (E'_R - E'_Y)] + 128$$

and:

$$\bar{C}_B = 224 [0.564 (E'_B - E'_Y)] + 128$$

which simplify to the following:

$$\bar{C}_R = 160 (E'_R - E'_Y) + 128$$

and:

$$\bar{C}_B = 126 (E'_B - E'_Y) + 128$$

and the corresponding level number, after quantization, is the nearest integer value.

The digital equivalents are termed  $Y$ ,  $C_R$  and  $C_B$ .

### 3.5.4 Construction of $Y$ , $C_R$ , $C_B$ via quantization of $E'_R$ , $E'_G$ , $E'_B$

In the case where the components are derived directly from the gamma pre-corrected component signals  $E'_R$ ,  $E'_G$ ,  $E'_B$ , or directly generated in digital form, then the quantization and encoding shall be equivalent to:

$$E'_{R_D} \text{ (in digital form)} = \text{int} (219 E'_R) + 16$$

$$E'_{G_D} \text{ (in digital form)} = \text{int} (219 E'_G) + 16$$

$$E'_{B_D} \text{ (in digital form)} = \text{int} (219 E'_B) + 16$$

Then:

$$Y = \frac{77}{256} E'_{R_D} + \frac{150}{256} E'_{G_D} + \frac{29}{256} E'_{B_D}$$

$$C_R = \frac{131}{256} E'_{R_D} - \frac{110}{256} E'_{G_D} - \frac{21}{256} E'_{B_D} + 128$$

$$C_B = -\frac{44}{256} E'_{R_D} - \frac{87}{256} E'_{G_D} + \frac{131}{256} E'_{B_D} + 128$$

taking the nearest integer coefficients, base 256. To obtain the 4:2:2 components  $Y$ ,  $C_R$ ,  $C_B$ , low-pass filtering and sub-sampling must be performed on the 4:4:4  $C_R$ ,  $C_B$  signals described above. Note should be taken that slight differences could exist between  $C_R$ ,  $C_B$  components derived in this way and those derived by analogue filtering prior to sampling.

### 3.5.5 Limiting of $Y$ , $C_R$ , $C_B$ signals

Digital coding in the form of  $Y$ ,  $C_R$ ,  $C_B$  signals can represent a substantially greater gamut of signal values than can be supported by the corresponding ranges of  $R$ ,  $G$ ,  $B$  signals. Because of this it is possible, as a result of electronic picture generation or signal processing, to produce  $Y$ ,  $C_R$ ,  $C_B$  signals which, although valid individually, would result in out-of-range values when converted to  $R$ ,  $G$ ,  $B$ . It is both more convenient and more effective to prevent this by applying limiting to the  $Y$ ,  $C_R$ ,  $C_B$  signals than to wait until the signals are in  $R$ ,  $G$ ,  $B$  form. Also, limiting can be applied in a way that maintains the luminance and hue values, minimizing the subjective impairment by sacrificing only saturation.

## 4 13 MHz family members

The following family members are defined in Part A:

- 4:2:2, 13.5 MHz for 4:3 aspect ratio, and for wide-screen 16:9 aspect ratio systems when it is necessary to keep the same analogue signal bandwidth and digital rates for both aspect ratios.
- 4:4:4, 13.5 MHz 4:3 and 16:9 aspect ratio systems with higher colour resolution.

## 5 18 MHz family members

The following family members are defined in Part B:

- 4:2:2, 18 MHz, for 16:9 aspect ratio systems with higher horizontal resolution compared with systems sampled at 13.5 MHz.
- 4:4:4, 18 MHz for 16:9 aspect ratio systems with higher colour resolution.

NOTE 1 – In the 4:4:4 members of the family the sampled signals may be luminance and colour difference signals (or, if used, red, green and blue signals).

### ANNEX 1

#### **Some guidance on the practical implementation of the filters specified in Appendix 2 to Part A and Appendix 2 to Part B**

In the proposals for the filters used in the encoding and decoding processes, it has been assumed that, in the post-filters which follow digital-to-analogue conversion, correction for the  $(\sin x/x)$  characteristic is provided. The passband tolerances of the filter plus  $(\sin x/x)$  corrector plus the theoretical  $(\sin x/x)$  characteristic should be the same as given for the filters alone. This is most easily achieved if, in the design process, the filter,  $(\sin x/x)$  corrector and delay equalizer are treated as a single unit.

The total delays due to filtering and encoding the luminance and colour-difference components should be the same. The delay in the colour-difference filter (Figs. 4a) and 4b)) is double that of the luminance filter (Figs. 3a) and 3b)). As it is difficult to equalize these delays using analogue delay networks without exceeding the passband tolerances, it is recommended that the bulk of the delay differences (in integral multiples of the sampling period) should be equalized in the digital domain. In correcting for any remainder, it should be noted that the sample-and-hold circuit in the decoder introduces a flat delay of one half a sampling period.

The passband tolerances for amplitude ripple and group delay are recognized to be very tight. Present studies indicate that it is necessary so that a significant number of coding and decoding operations in cascade may be carried out without sacrifice of the potentially high quality of the 4:2:2 coding standard. Due to limitations in the performance of currently available measuring equipment, manufacturers may have difficulty in economically verifying compliance with the tolerances of individual filters on a production basis. Nevertheless, it is possible to design filters so that the specified characteristics are met in practice, and manufacturers are required to make every effort in the production environment to align each filter to meet the given templates.

The specifications given in Appendix 2 to Part A and Appendix 2 to Part B were devised to preserve as far as possible the spectral content of the  $Y$ ,  $C_R$ ,  $C_B$  signals throughout the component signal chain. It is recognized, however, that the colour-difference spectral characteristic must be shaped by a slow roll-off filter inserted at picture monitors, or at the end of the component signal chain.

## PART A

## TO ANNEX 1

**The 13.5 MHz members of the family****1 Encoding parameter values for the 4:2:2, 13.5 MHz member of the family**

The specification (see Table 2) applies to the 4:2:2 member of the family, to be used for the standard digital interface between main digital studio equipment and for international programme exchange of 4:3 aspect ratio digital television or wide-screen 16:9 aspect ratio digital television when it is necessary to keep the same analogue signal bandwidth and digital rates.

TABLE 2

Parameters	525-line, 60 field/s systems	625-line, 50 field/s systems
1. Coded signals: $Y$ , $C_R$ , $C_B$	These signals are obtained from gamma pre-corrected signals, namely: $E'_Y, E'_R - E'_Y, E'_B - E'_Y$ (see § 3.5)	
2. Number of samples per total line: – luminance signal ( $Y$ ) – each colour-difference signal ( $C_R, C_B$ )	858 429	864 432
3. Sampling structure	Orthogonal, line, field and frame repetitive. $C_R$ and $C_B$ samples co-sited with odd (1st, 3rd, 5th, etc.) $Y$ samples in each line	
4. Sampling frequency: – luminance signal – each colour-difference signal	13.5 MHz 6.75 MHz The tolerance for the sampling frequencies should coincide with the tolerance for the line frequency of the relevant colour television standard	
5. Form of coding	Uniformly quantized PCM, 8 (optionally 10) bits per sample, for the luminance signal and each colour-difference signal	
6. Number of samples per digital active line: – luminance signal – each colour-difference signal	720 360	
7. Analogue-to-digital horizontal timing relationship: – from end of digital active line to $O_H$	16 luminance clock periods	12 luminance clock periods
8. Correspondence between video signal levels and quantization levels: – scale – luminance signal – each colour-difference signal	(See § 3.4) (Values are decimal) 0 to 255 220 quantization levels with the black level corresponding to level 16 and the peak white level corresponding to level 235. The signal level may occasionally excise beyond level 235 225 quantization levels in the centre part of the quantization scale with zero signal corresponding to level 128	
9. Code-word usage	Code words corresponding to quantization levels 0 and 255 are used exclusively for synchronization. Levels 1 to 254 are available for video	

## 2 Encoding parameter values for the 4:4:4, 13.5 MHz member of the family

The specifications given in Table 3 apply to the 4:4:4 member of the family suitable for television source equipment and high-quality video signal processing applications.

TABLE 3

Parameters	525-line, 60 field/s systems	625-line, 50 field/s systems
1. Coded signals: $Y$ , $C_R$ , $C_B$ or $R$ , $G$ , $B$	These signals are obtained from gamma pre-corrected signals, namely: $E'_Y$ , $E'_{R-}$ $E'_Y$ , $E'_{B-}$ $E'_Y$ or $E'_{R-}$ , $E'_G$ , $E'_B$	
2. Number of samples per total line for each signal	858	864
3. Sampling structure	Orthogonal, line, field and frame repetitive. The three sampling structures to be coincident and coincident also with the luminance sampling structure of the 4:2:2 member	
4. Sampling frequency for each signal	13.5 MHz	
5. Form of coding	Uniformly quantized PCM, 8 (optionally 10) bits per sample	
6. Duration of the digital active line expressed in number of samples	720	
7. Correspondence between video signal levels and the 8 most significant bits (MSB) of the quantization level for each sample: – scale – $R$ , $G$ , $B$ or luminance signal <sup>(1)</sup>  – each colour-difference signal <sup>(1)</sup>	(See § 3.4) (Values are decimal)  0 to 255 220 quantization levels with the black level corresponding to level 16 and the peak white level corresponding to level 235. The signal level may occasionally excise beyond level 235  225 quantization levels in the centre part of the quantization scale with zero signal corresponding to level 128	

<sup>(1)</sup> If used.

### APPENDIX 1 TO PART A

## Definition of signals used in the digital coding standards

### 1 Relationship of digital active line to analogue sync reference

The relationship between the digital active line luminance samples and the analogue synchronizing reference is shown in:

- Fig. 1 for 625-line 13.5 MHz (see Table 2);
- Fig. 2 for 525-line 13.5 MHz (see Table 3).

In the figures, the sampling point occurs at the commencement of each block.

The respective numbers of colour-difference samples can be obtained by dividing the number of luminance samples by two. The (12,132), and (16,122) were chosen symmetrically to dispose the digital active line about the permitted variations. They do not form part of the digital line specification and relate only to the analogue interface.

FIGURE 1

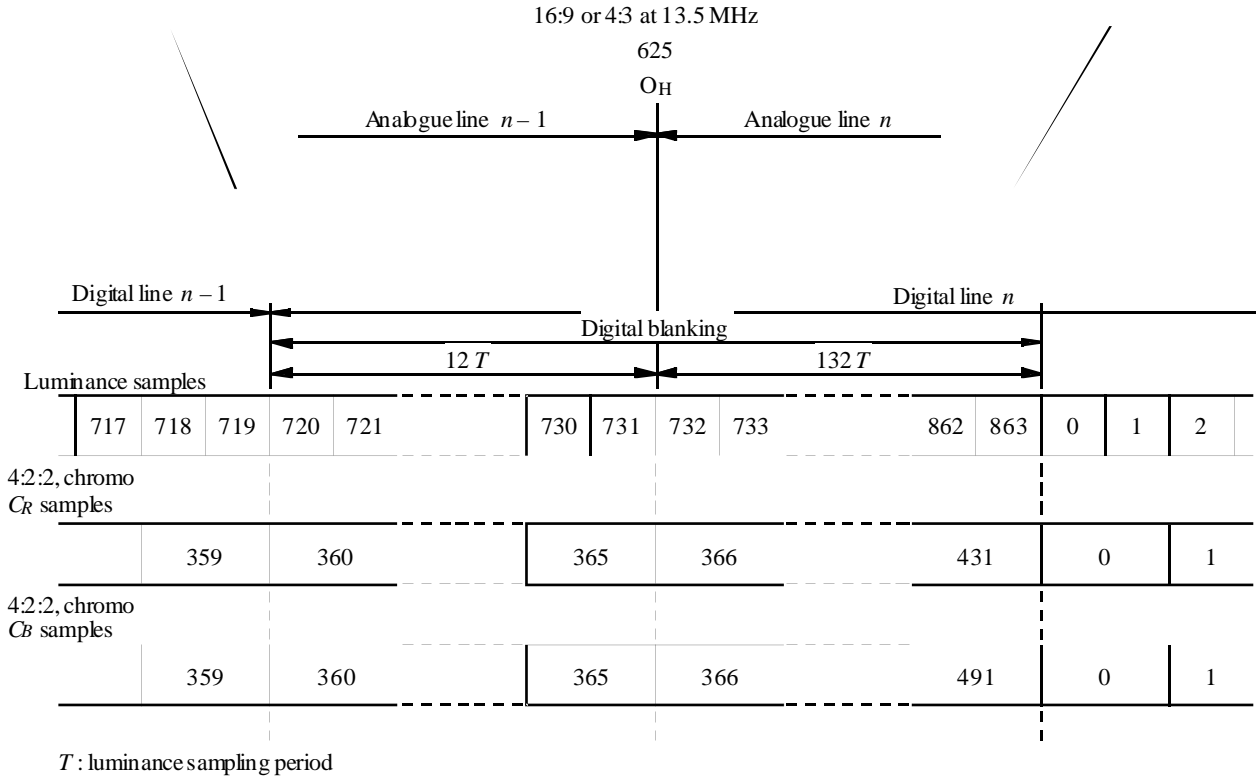
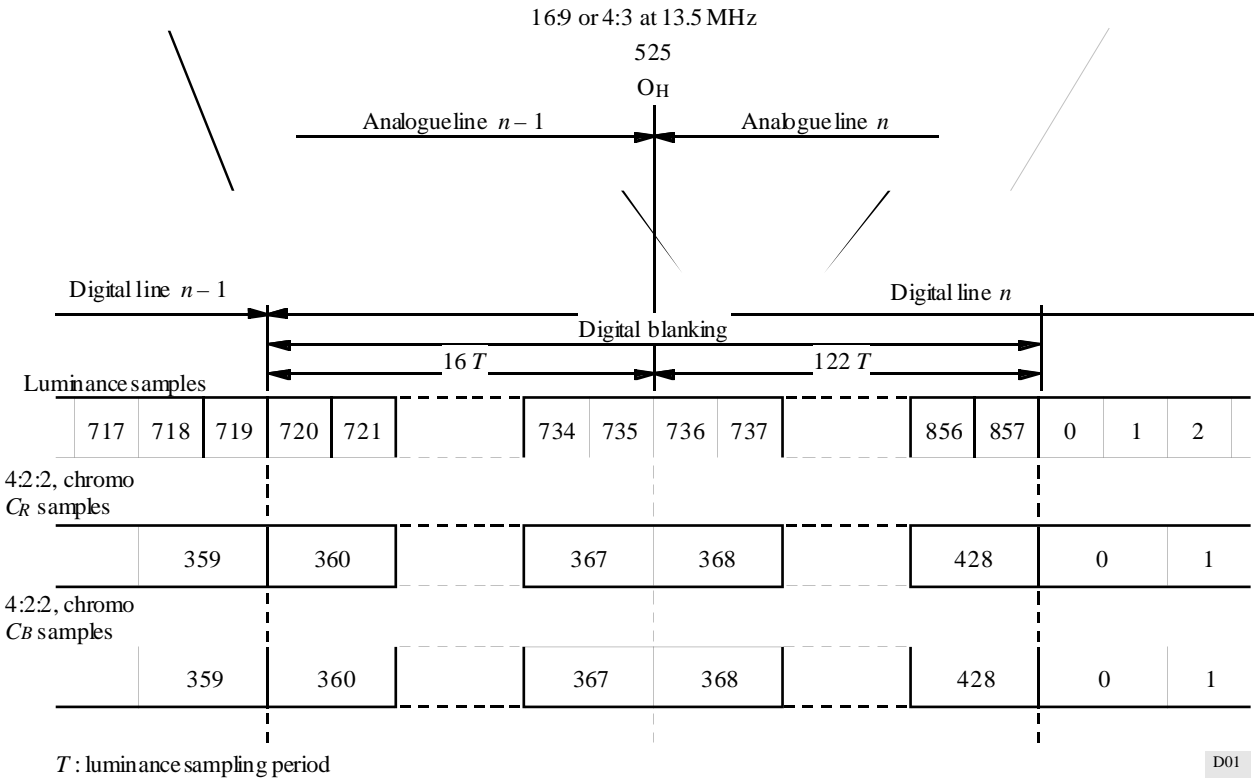

FIGURE 2





APPENDIX 2  
TO PART A

**Filtering characteristics**

FIGURE 3  
Specification for a luminance or RGB signal filter  
used when sampling at 13.5 MHz

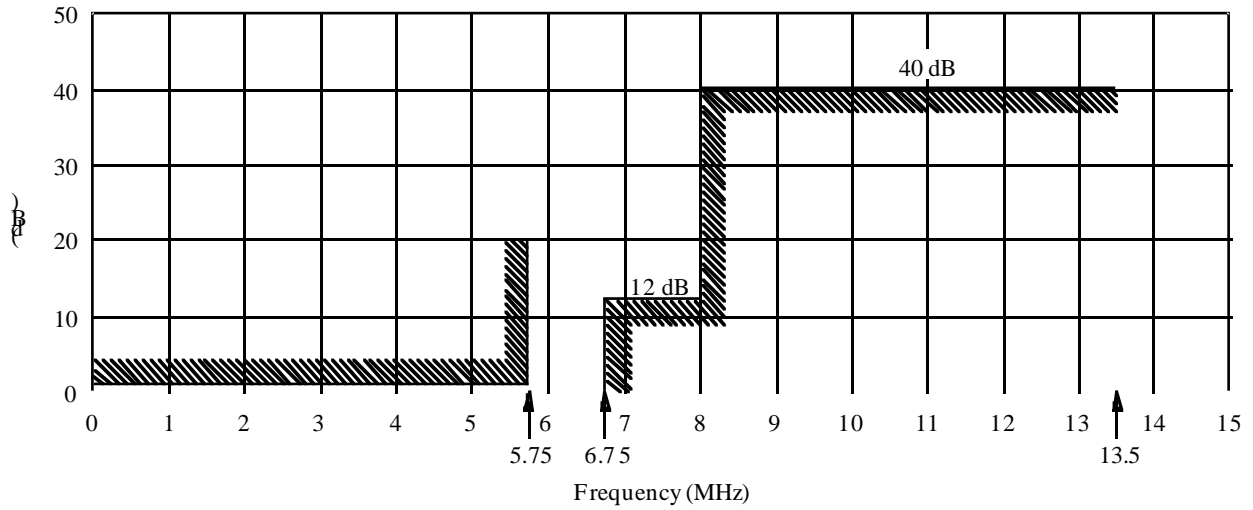

a) Template for insert on loss/frequency characteristic

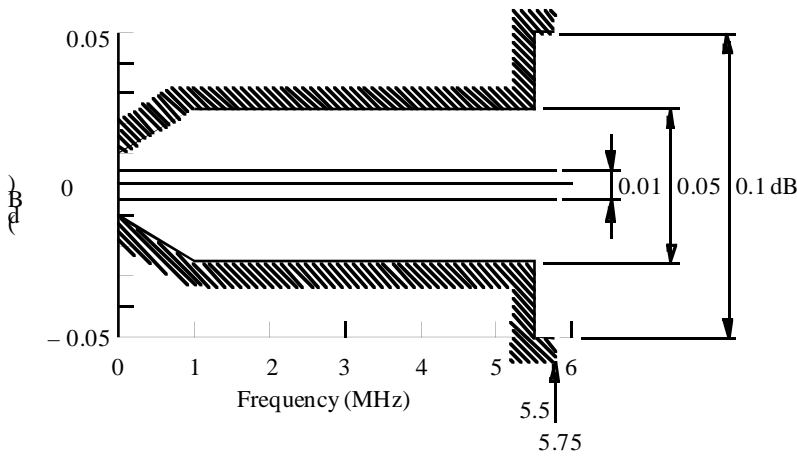

b) Passband ripple tolerance

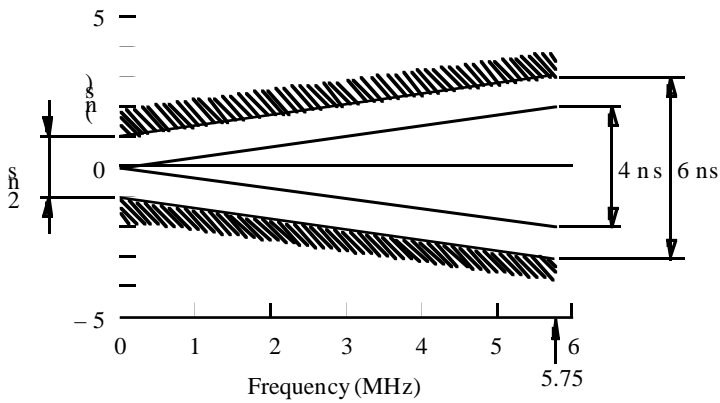

c) Passband group-delay tolerance

Note 1 – The lowest indicated values in b) and c) are for 1 kHz (instead of 0 MHz).

FIGURE 4  
Specification for a colour-difference signal filter  
used when sampling at 6.75 MHz

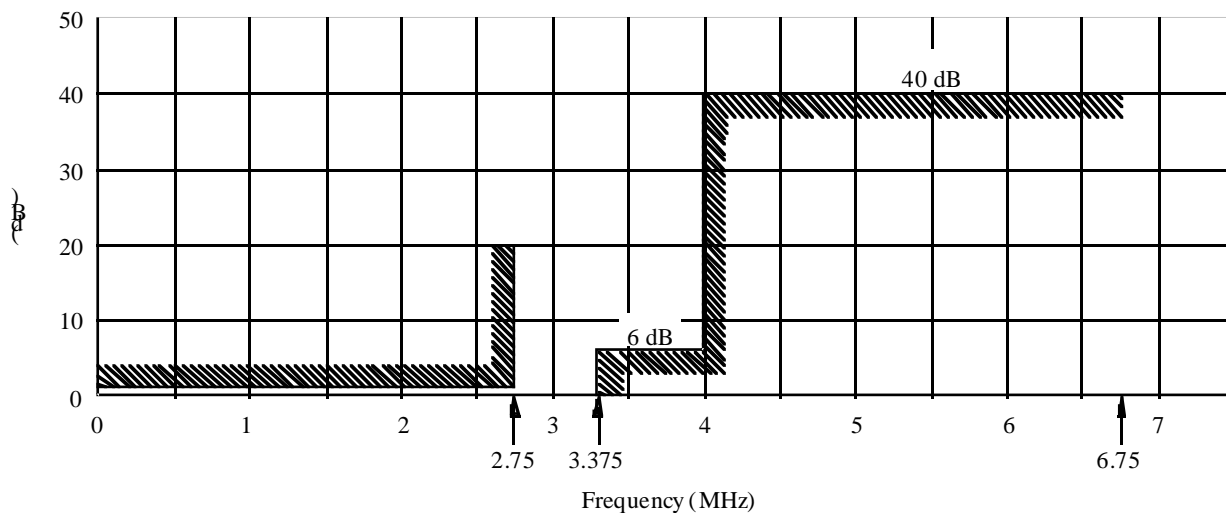

a) Template for insertion loss/frequency characteristic

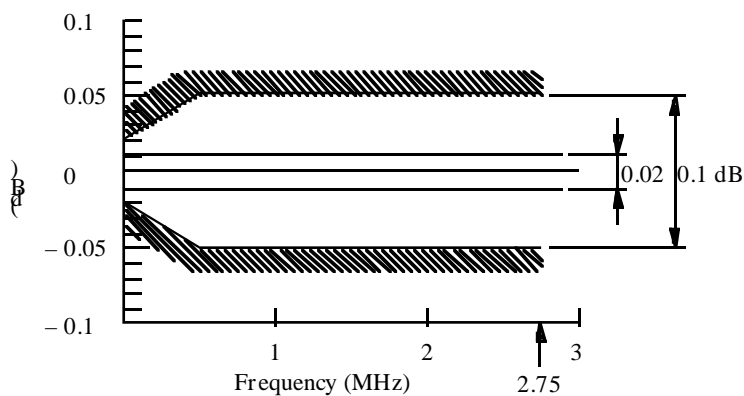

b) Passband ripple tolerance

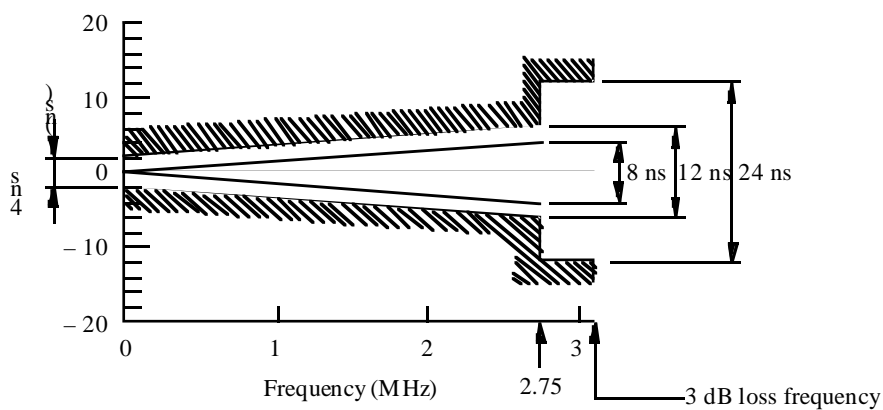

c) Passband group-delay tolerance

Note 1 – The lowest indicated values in b) and c) are for 1 kHz (instead of 0 MHz).

FIGURE 5  
 Specification for a digital filter for sampling-rate conversion  
 from 4:4:4 to 4:2:2 colour-difference signals

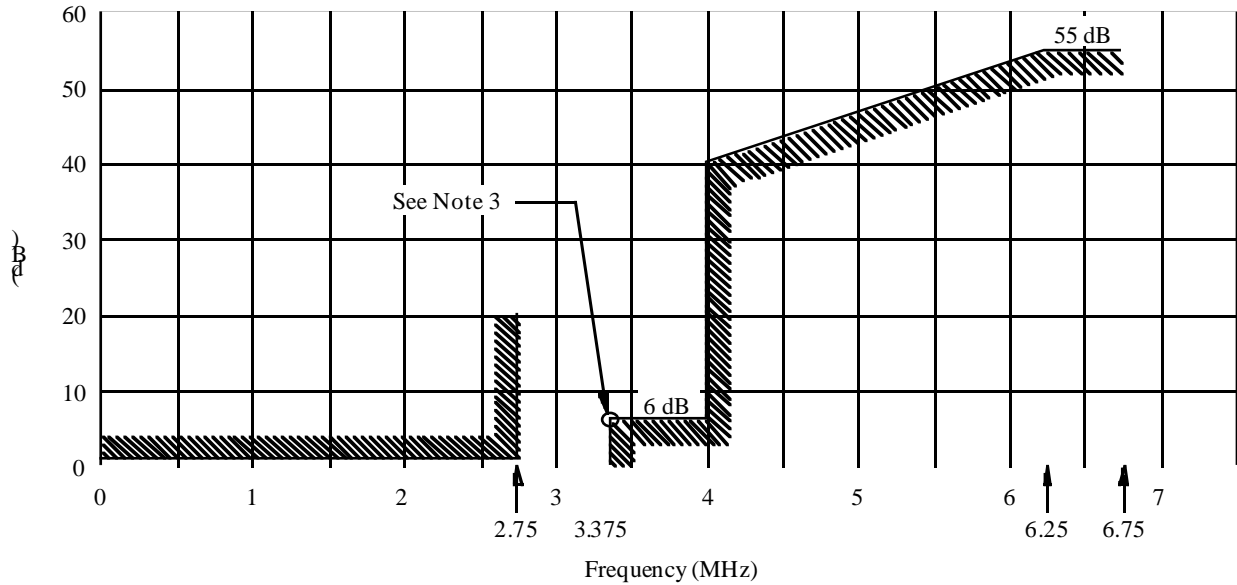

a) Template for insertion loss/frequency characteristic

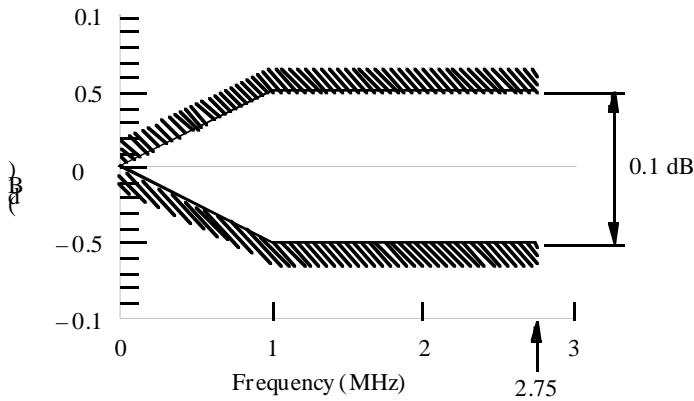

b) Passband ripple tolerance

Notes to Figs. 3, 4 and 5:

Note 1 – Ripple and group delay are specified relative to their values at 1 kHz. The full lines are practical limits and the dashed lines give suggested limits for the theoretical design.

Note 2 – In the digital filter, the practical and design limits are the same. The delay distortion is zero, by design.

Note 3 – In the digital filter (Fig. 5), the amplitude/frequency characteristic (on linear scales) should be skew-symmetrical about the half-amplitude point, which is indicated on the figure.

Note 4 – In the proposals for the filters used in the encoding and decoding processes, it has been assumed that, in the post-filters which follow digital-to-analogue conversion, correction for the  $(\sin x/x)$  characteristic of the sample-and-hold circuits is provided.

## PART B

## TO ANNEX 1

**The 18 MHz members of the family****1 Encoding parameter values for the 4:2:2, 18 MHz member of the family**

The specification (see Table 4) applies to the 4:2:2 member of the family used for the standard digital interface between main digital studio equipment and for international programme exchange of 16:9 aspect ratio television with higher horizontal resolution compared with 16:9 systems sampled at 13.5 MHz.

TABLE 4

Parameters	525-line, 60 field/s systems	625-line, 50 field/s systems
1. Coded signals: $Y, C_R, C_B$	These signals are obtained from gamma pre-corrected signals, namely: $E'_Y, E'_R - E'_Y, E'_B - E'_Y$ (see Annex § 3.5)	
2. Number of samples per total line: – luminance signal ( $Y$ ) – each colour-difference signal ( $C_R, C_B$ )	1144 572	1152 576
3. Sampling structure	Orthogonal, line, field and frame repetitive. $C_R$ and $C_B$ samples co-sited with odd (1st, 3rd, 5th, etc.) $Y$ samples in each line	
4. Sampling frequency: – luminance signal – each colour-difference signal	18 MHz 9 MHz The tolerance for the sampling frequencies should coincide with the tolerance for the line frequency of the relevant colour television standard	
5. Form of coding	Uniformly quantized PCM, 8 (optionally 10) bits per sample, for the luminance signal and each colour-difference signal	
6. Number of samples per digital active line: – luminance signal – each colour-difference signal	960 480	
7. Analogue-to-digital horizontal timing relationship: – from end of digital active line to $O_H$	To be determined (see Appendix 1 to Part B)	
8. Correspondence between video signal levels and quantization levels: – scale – luminance signal  – each colour-difference signal	(See § 3.4) (Values are decimal) 0 to 255 220 quantization levels with the black level corresponding to level 16 and the peak white level corresponding to level 235. The signal level may occasionally excursion beyond level 235 225 quantization levels in the centre part of the quantization scale with zero signal corresponding to level 128	
9. Code-word usage	Code words corresponding to quantization levels 0 and 255 are used exclusively for synchronization. Levels 1 to 254 are available for video	

## 2 Encoding parameter values for the 4:4:4, 18 MHz member of the family

The specifications given in Table 5 apply to the 4:4:4 member of the family suitable for television source equipment and high-quality video signal processing applications.

TABLE 5

Parameters	525-line, 60 field/s systems	625-line, 50 field/s systems
1. Coded signals: $Y, C_R, C_B$ or $R, G, B$	These signals are obtained from gamma-corrected signals, namely: $E'_Y, E'_{R-}, E'_{G-}, E'_{B-}$ or $E'_R, E'_G, E'_B$	
2. Number of samples per total line for each signal	1144	1152
3. Sampling structure	Orthogonal, line, field and frame repetitive. The three sampling structures to be coincident and coincident also with the luminance sampling structure of the 4:2:2 member	
4. Sampling frequency for each signal	18 MHz	
5. Form of coding	Uniformly quantized PCM, 8 (optionally 10) bits per sample	
6. Duration of the digital active line expressed in number of samples	960	
7. Correspondence between video signal levels and the 8 most significant bits (MSB) of the quantization level for each sample: – scale – $R, G, B$ or luminance signal <sup>(1)</sup> – each colour-difference signal <sup>(1)</sup>	(See § 3.4) (Values are decimal)  0 to 255  220 quantization levels with the black level corresponding to level 16 and the peak white level corresponding to level 235. The signal level may occasionally excure beyond level 235  225 quantization levels in the centre part of the quantization scale with zero signal corresponding to level 128	

<sup>(1)</sup> If used.

### APPENDIX 1

#### TO PART B

### Definition of signals used in the digital coding standards

#### 1 Relationship of digital active line to analogue sync reference

Further study is required to specify absolute values for these parameters, while ensuring consistent picture positioning and geometry across different standards. For practical application, the correct relationship is achieved when the picture to sync relationship in the analogue domain is identical for images converted from 13.5 and 18 MHz sampled digital representations.

APPENDIX 2

TO PART B

Filtering characteristics

FIGURE 6

Specification for a luminance or RGB signal filter used when sampling at 18 MHz

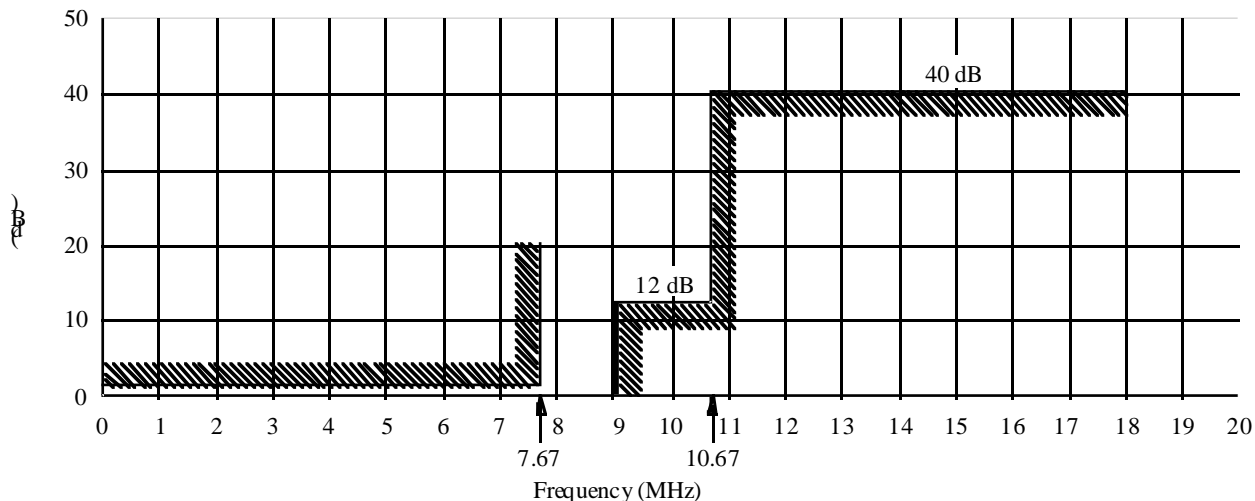

a) Template for insertion loss/frequency characteristic

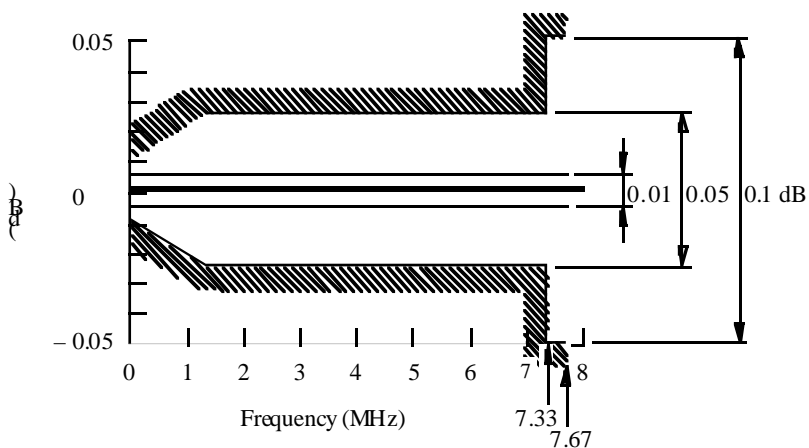

b) Passband ripple tolerance

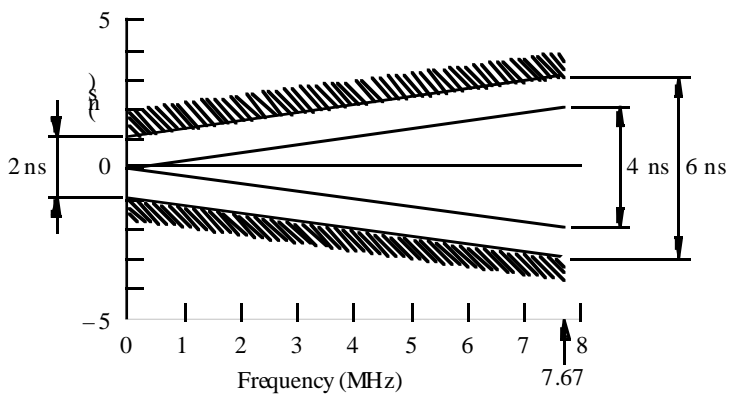

c) Passband group-delay tolerance

Note 1 – The lowest indicated values in b) and c) are for 1 kHz (instead of 0 MHz).

FIGURE 7  
Specification for a colour-difference signal filter used when sampling at 9 MHz

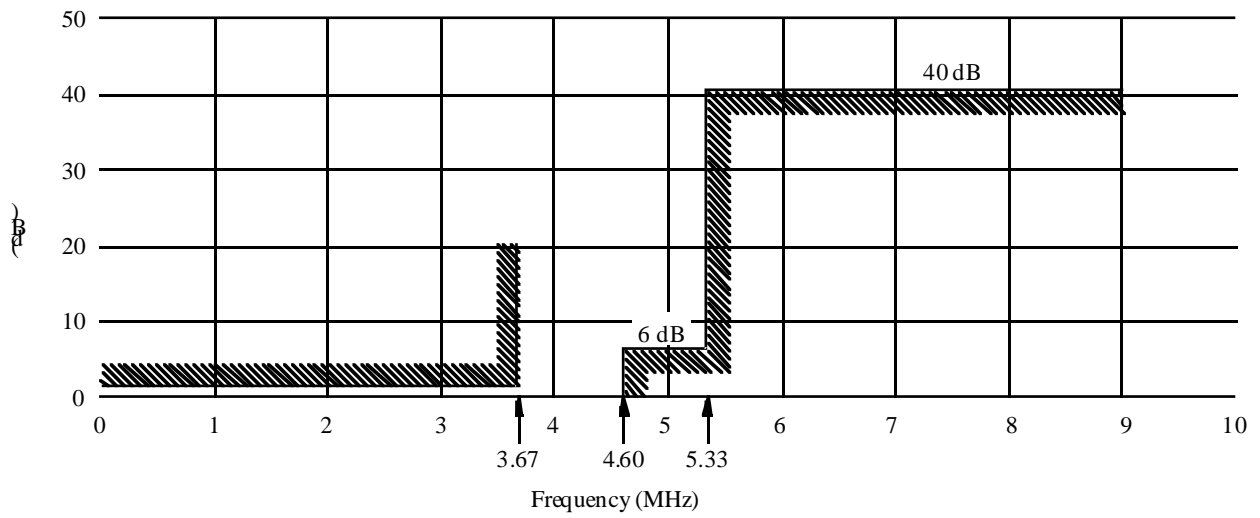

a) Template for insertion loss/frequency characteristic

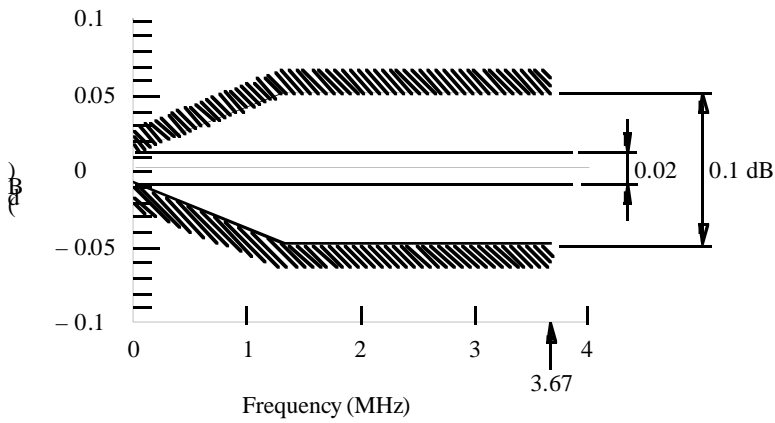

b) Passband ripple tolerance

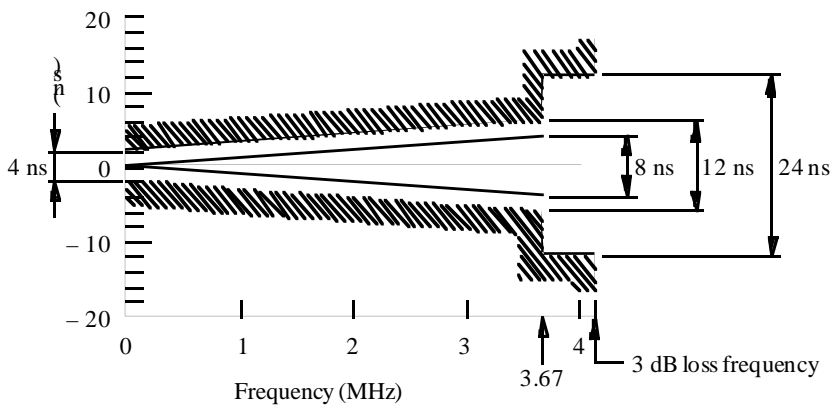

c) Passband group-delay tolerance

Note 1 – The lowest indicated values in b) and c) are for 1 kHz (instead of 0 MHz).

FIGURE 8  
Specification for a digital filter for sampling-rate conversion  
from 4:4:4 to 4:2:2 colour-difference signals

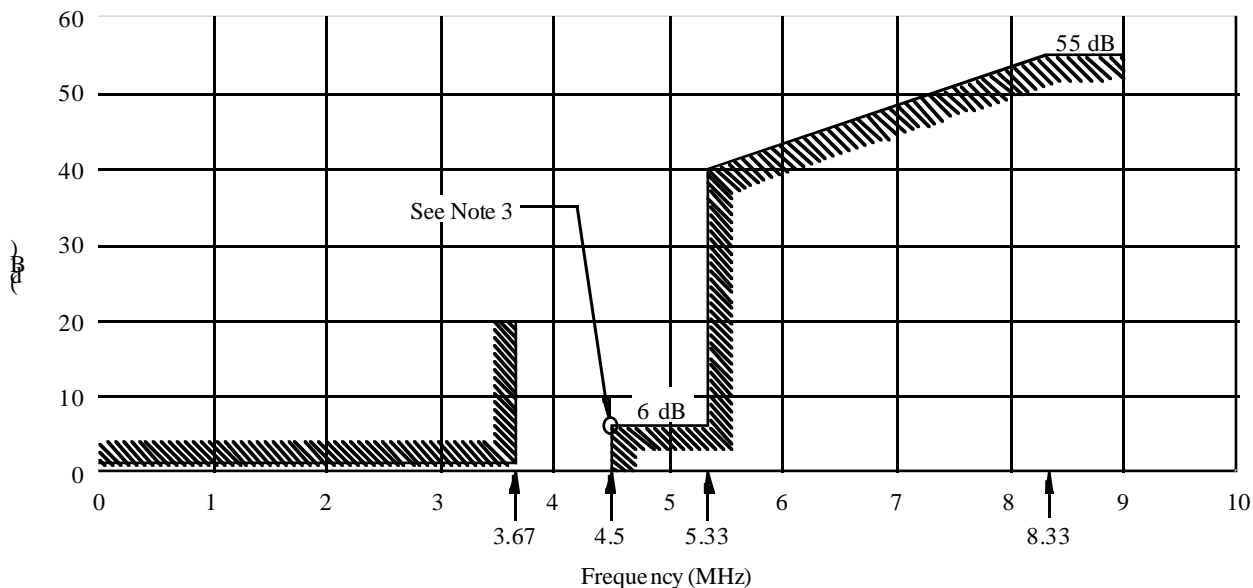

a) Template for insertion loss/frequency characteristic

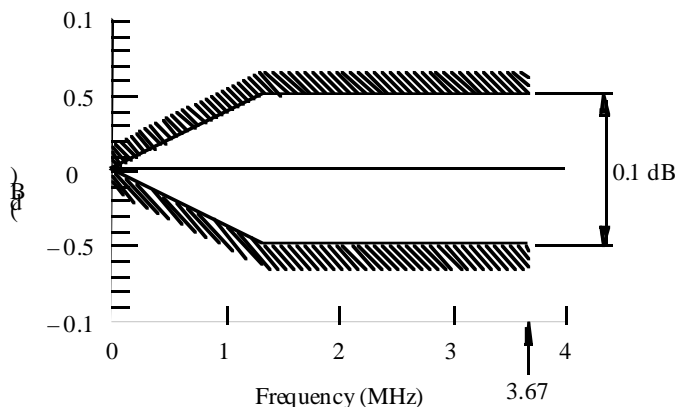

b) Passband ripple tolerance

Notes to Figs. 6, 7 and 8:

Note 1 – Ripple and group delay are specified relative to their values at 1 kHz. The full lines are practical limits and the dashed lines give suggested limits for the theoretical design.

Note 2 – In the digital filter, the practical and design limits are the same. The delay distortion is zero, by design.

Note 3 – In the digital filter (Fig. 8), the amplitude/frequency characteristic (on linear scales) should be skew-symmetrical about the half-amplitude point, which is indicated on the figure.

Note 4 – In the proposals for the filters used in the encoding and decoding processes, it has been assumed that, in the post-filters which follow digital-to-analogue conversion, correction for the  $(\sin x/x)$  characteristic of the sample-and-hold circuits is provided.



## Characteristics of television systems

CCIR Report 624-4

---

### CHARACTERISTICS OF TELEVISION SYSTEMS

(Question 1/11)

Section 11A: Characteristics of systems for monochrome and colour television

Report 624-4

(1974-1987-1982-1986-1990)

The tables in this document are given for information purposes and contain details of a number of different television systems in use at the time of the XVIIth Plenary Assembly of the CCIR, Duesseldorf, 1990.

Information on the results of the comparative laboratory tests carried out on the various colour television systems in the period 1963-1966 by broadcasting authorities, administrations and industrial organizations, together with the main parameter of systems may be found in Reports 406 and 407, XXIIth Plenary Assembly, New Delhi, 1970

All television systems listed in the Report employ an aspect ratio of the picture display (width/height) of 4/3, a scanning sequence from left to right and from top to bottom and an interlace ratio of 2/1, resulting in a picture (frame) frequency of half the field frequency. All systems are capable of operating independently of the power supply frequency.

The full report can be obtained from:

The International Radio Consultative Committee  
International Telecommunications Union  
Place des Nations  
CH-1211 Geneva  
20 Switzerland  
Telephone: (011) 4122 730 5800

---

*(ALSO RESOLUTIONS AND OPINIONS) VOLUME XI — PART 1  
BROADCASTING SERVICE (TELEVISION)***CCIR**

1. The International Radio Consultative Committee (CCIR) is the permanent organ of the International Telecommunication Union responsible under the International Telecommunication Convention "...to study technical and operating questions relating specifically to radiocommunications without limit of frequency range, and to issue recommendations on them..." (International Telecommunication Convention, Nairobi 1982, First Part, Chapter I, Art. 11, No. 83).<sup>1</sup>
2. The objectives of the CCIR are in particular:
  - a. to provide the technical bases for use by administrative radio conferences and radiocommunication services for efficient utilization of the radio-frequency spectrum and the geostationary-satellite orbit, bearing in mind the needs of the various radio services;
  - b. to recommend performance standards for radio systems and technical arrangements which assure their effective and compatible interworking in international telecommunications;
  - c. to collect, exchange, analyze and disseminate technical information resulting from studies by the CCIR, and other information available, for the development, planning and operation of radio systems, including any necessary special measures required to facilitate the use of such information in developing countries.

---

1. See also the Constitution of the ITU, Nice, 1989, Chapter 1, Art. 11, No. 84.

## Rec. 656

## RECOMMENDATION 656

**INTERFACES FOR DIGITAL COMPONENT VIDEO SIGNALS  
IN 525-LINE AND 625-LINE TELEVISION SYSTEMS**

(1986)

The CCIR,

## CONSIDERING

- a. that there are clear advantages for television broadcasting organizations and programme producers in digital studio standards which have the greatest number of significant parameter values common to 525-line and 625-line systems;
- b. that a world-wide compatible digital approach will permit the development of equipment with many common features, permit operating economies and facilitate the international exchange of programmes;
- c. that to implement the above objectives, agreement has been reached on the fundamental encoding parameters of digital television for studios in the form of Recommendation 601;
- d. that the practical implementation of Recommendation 601 requires definition of details of interfaces and the data streams traversing them;
- e. that such interfaces should have a maximum of commonality between 525-line and 625-line versions;
- f. that in the practical implementation of Recommendation 601 it is desirable that interfaces be defined in both serial and parallel forms;
- g. that digital television signals produced by these interfaces may be a potential source of interference to other services, and due notice must be taken of No. 964 of the Radio Regulations,

## UNANIMOUSLY RECOMMENDS

that where interfaces are required for component-coded digital video signals in television studios, the interfaces and the data streams that will traverse them should be in accordance with the following description, defining both bit-parallel and bit-serial implementations.

**1. Introduction**

This Recommendation describes the means of interconnecting digital television equipment operating on the 525-line or 625-line standards and complying with the 4 : 2 : 2 encoding parameters as defined in Recommendation 601.

Part I describes the signal format common to both interfaces.

Part II describes the particular characteristics of the bit-parallel interface.

Part III describes the particular characteristics of the bit-serial interface.

## PART I

## COMMON SIGNAL FORMAT OF THE INTERFACES

**1. General description of the interfaces**

The interfaces provide a unidirectional interconnection between a single source and a single destination.

A signal format common to both parallel and serial interfaces is described in § 2 below.

**Rec. 656**

The data signal are in the form of binary information coded in 8-bit words. These signals are:

- video data;
- timing reference codes;
- ancillary data;
- identification codes.

**2. Video data****2.1 Coding characteristics**

The video data is in compliance with Recommendation 601, and with the field-blanking definition shown in Table 1.

TABLE I — *Field interval definitions*

		625	525
V-digital field blanking			
Field 1	Start (V = 1)	Line 624	Line 1
	Finish (V = 0)	Line 23	Line 10
Field 2	Start (V = 1)	Line 311	Line 264
	Finish (V = 0)	Line 336	Line 273
F-digital field identification			
Field 1	F = 0	Line 1	Line 4
Field 2	F = 1	Line 313	Line 266

*Note 1* — Signals F and V change state synchronously with the end of active video timing reference code at the beginning of the digital line.

*Note 2* — Definition of line numbers is to be found in Report 624. Note that digital line number changes state prior to 0<sub>H</sub> as shown in Fig. 1.

**2.2 Video data format**

The data words 0 and 255 (00 and FF in hexadecimal notation) are reserved for data identification purposes and consequently only 254 of the possible 256 words may be used to express a signal value.

The video data words are conveyed as a 27 Mwords/s multiplex in the following order:

$$C_B, Y, C_R, Y, C_B, Y, C_R, \text{ etc.}$$

where the word sequence  $C_B, Y, C_R$ , refers to co-sited luminance and colour-difference samples and the following word, Y, corresponds to the next luminance sample.

Rec. 656

2.3 Timing relationship between video data and the analogue synchronizing waveform

2.3.1 Line interval

The digital active line begins at 244 words (in the 525-line standard) or at 264 words (in the 625-line standard) after the leading edge of the analogue line synchronization pulse, this time being specified between half-amplitude points.

Figure 1 shows the timing relationship between video and the analogue line synchronization.

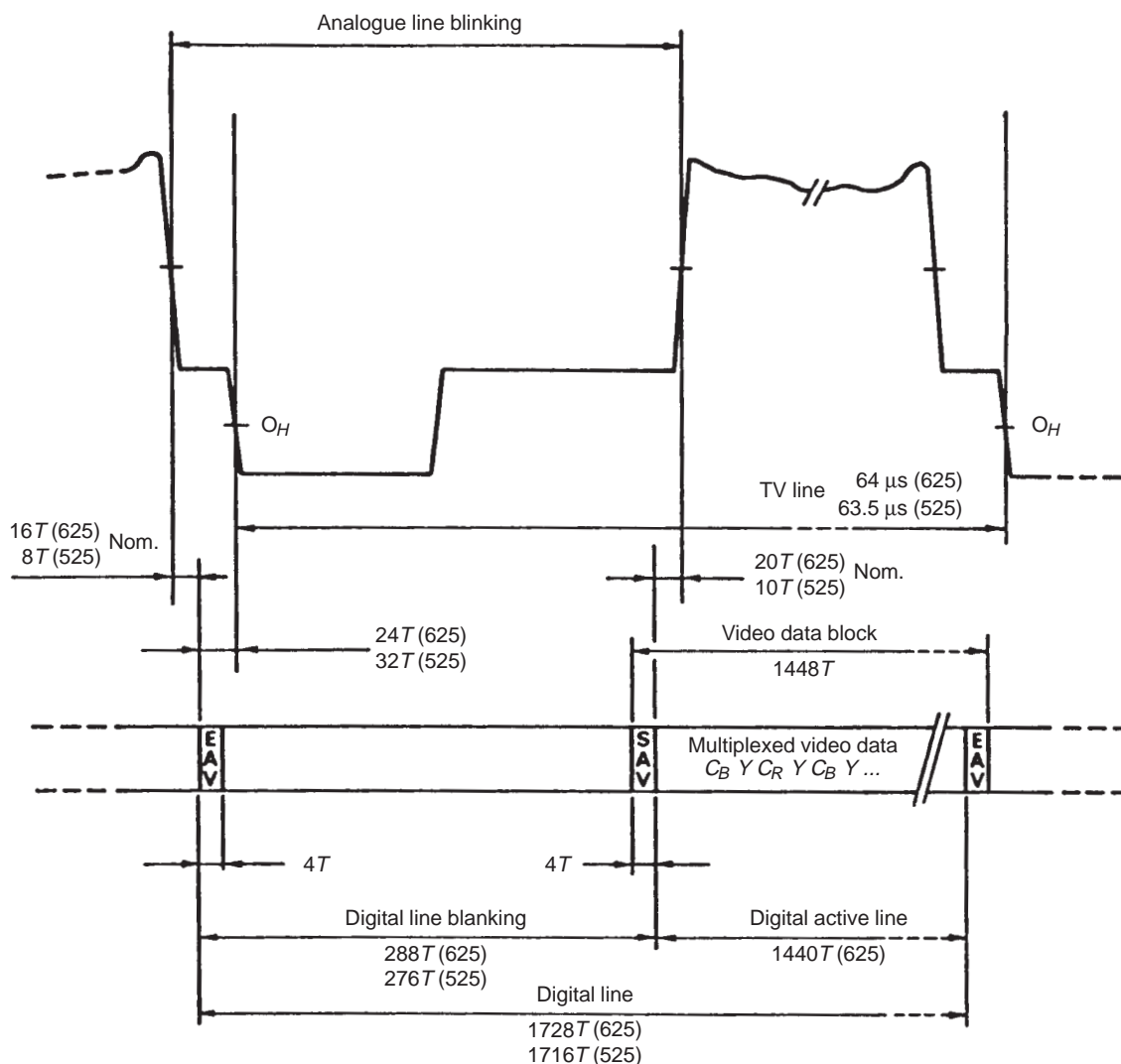

FIGURE 1 – Data format and timing relationship with the analogue video signal

T: clock period 37 ns nom.  
 SAV: start of active video timing reference code  
 EAV: end of active video timing reference code

## Rec. 656

2.3.2 *Field interval*

The start of the digital field is fixed by the position specified for the start of the digital line: the digital field starts 32 words (in the 525-line systems) and 24 words (in the 625-line systems) prior to the lines indicated in Table I.

2.4 *Video timing reference codes (SAV, EAV)*

There are two timing reference codes, one at the beginning of each video data block (Start of Active Video, SAV) and one at the end of each video data block (End of Active Video, EAV) as shown in Fig. 1.

Each timing reference code consists of a four word sequence in the following format: FF 00 00 XY. (Values are expressed in hexadecimal notation. Codes FF, 00 are reserved for use in timing reference codes.) The first three words are a fixed preamble. The fourth word contains information defining field 2 identification, the state of field blanking, and the state of line blanking. The assignment of bits within the timing reference code is shown below in Table II.

TABLE II — *Video timing reference codes*

Word	Bit No.							
	7 (MSB)	6	5	4	3	2	1	0 (MSB)
First	1	1	1	1	1	1	1	1
Second	0	0	0	0	0	0	0	0
Third	0	0	0	0	0	0	0	0
Fourth	1	F	V	H	P <sub>3</sub>	P <sub>2</sub>	P <sub>1</sub>	P <sub>0</sub>

F = 0 during field 1  
1 during field 2

V = 0 elsewhere  
1 during field blanking

H = 0 in SAV  
1 in EAV

P<sub>0</sub>, P<sub>1</sub>, P<sub>2</sub>, P<sub>3</sub> : protection bits (see Table III).

MSB: most significant bit

LSB: least significant bit

## Rec. 656

Table I defines the state of the V and F bits.

Bits  $P_0$ ,  $P_1$ ,  $P_2$ ,  $P_3$ , have states dependent on the states of the bits F, V and H as shown in Table III. At the receiver this arrangement permits one-bit errors to be corrected and two-bit errors to be detected.

TABLE III — *Protection bits*

Bit No.	7	6	5	4	3	2	1	0
Function	Fixed 1	F	V	H	$P_3$	$P_2$	$P_1$	$P_0$
0	1	0	0	0	0	0	0	0
1	1	0	0	1	1	1	0	1
2	1	0	1	0	1	0	1	1
3	1	0	1	1	0	1	1	0
4	1	1	0	0	0	1	1	1
5	1	1	0	1	1	0	1	0
6	1	1	1	0	1	1	0	0
7	1	1	1	1	0	0	0	1

2.5 *Ancillary data*

Provision is made for ancillary data to be inserted synchronously into the multiplex during the blanking intervals at a rate of 27 Mwords/s. Such data is conveyed by one or more 7-bit words, each with an additional parity bit (LSB) giving odd parity.

Each ancillary data block, when used, should be constructed as shown in Table IV from the timing reference code ANC and a data field.

2.6 *Data words during blanking*

The data words occurring during digital blanking intervals that are not used for the timing reference code ANC or for ancillary data are filled with the sequence 80, 10, 80, 10, etc. (values are expressed in hexadecimal notation) corresponding to the blanking level of the  $C_B$ , Y,  $C_R$ , Y signals respectively, appropriately placed in the multiplexed data.

Rec. 656

TABLE IV — Ancillary data block

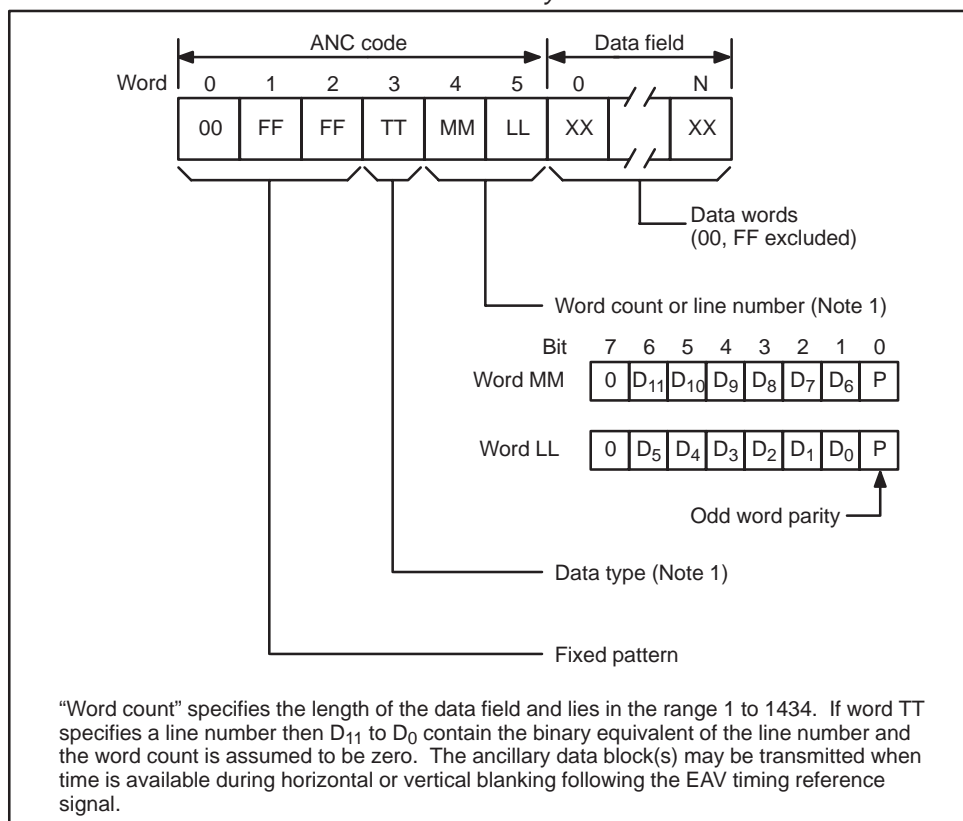

Note 1 — The precise location of the ancillary data blocks and the coding of words 3, 4 and 5 require further study.

PART II

BIT-PARALLEL INTERFACE

1. General description of the interface

The bits of the digital code words that describe the video signal are transmitted in parallel by means of eight conductor pairs, where each carries a multiplexed stream of bits (of the same significance) of each of the component signals, C<sub>B</sub>, Y, C<sub>R</sub>, Y. The eight pairs also carry ancillary data that is time-multiplexed into the data stream during video blanking intervals. A ninth pair provides a synchronous clock at 27MHz.

The signals on the interface are transmitted using balanced conductor pairs. Cable lengths of up to 50 m (≅ 160 feet) without equalization and up to 200 m (≅ 650 feet) with appropriate equalization (see § 6) may be employed.

The interconnection employs a twenty-five pin D-subminiature connector equipped with a locking mechanism (see § 5).

For convenience, the eight bits of the data word are assigned the names DATA 0 to DATA 7. The entire word is designated as DATA (0-7). DATA 7 is the most significant bit.

Video data is transmitted in NRZ form in real time (unbuffered) in blocks, each comprising one active television line.

2. Data signal format

The interface carries data in the form of 8 parallel data bits and a separate synchronous clock. Data is coded in NRZ form. The recommended data format is described in Part I.



## Rec. 656

## 3. Clock signal

## 3.1 General

The clock signal is a 27 MHz square wave where the 0-1 transition represents the data transfer time. This signal has the following characteristics:

Width:  $18.5 \pm 3$  ns

Jitter: Less than 3 ns from the average period over one field.

## 3.2 Clock-to-data timing relationship

The positive transition of the clock signal shall occur midway between data transitions as shown in Fig. 2.

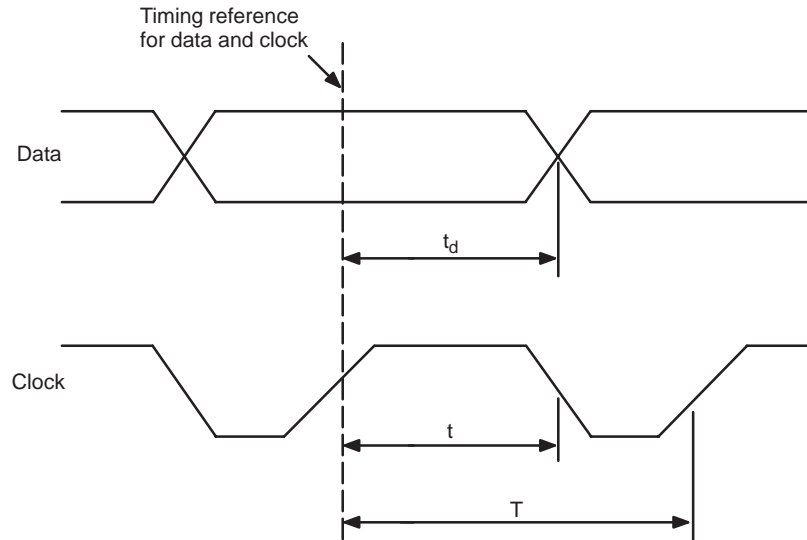

FIGURE 2 — Clock-to-data timing (at source)

$$\text{Clock period (625): } T = \frac{1}{1728 f_H} = 37 \text{ ns}$$

$$\text{Clock period (525): } T = \frac{1}{1716 f_H} = 37 \text{ ns}$$

$$\text{Clock pulse width: } t = 18.5 \pm 3 \text{ ns}$$

$$\text{Data timing – sending end: } t_d = 18.5 \pm 3 \text{ ns}$$

$f_H$ : line frequency

## 4. Electrical characteristics of the interface

## 4.1 General

The interface employs nine line drivers and nine line receivers.

Each line driver (source) has a balanced output and the corresponding line receiver (destination) a balanced input (see Fig. 3).

Although the use of ECL technology is not specified, the line driver and receiver must be ECL-compatible, i.e. they must permit the use of ECL for either drivers or receivers.

All digital signal time intervals are measured between the half-amplitude points.

## Rec. 656

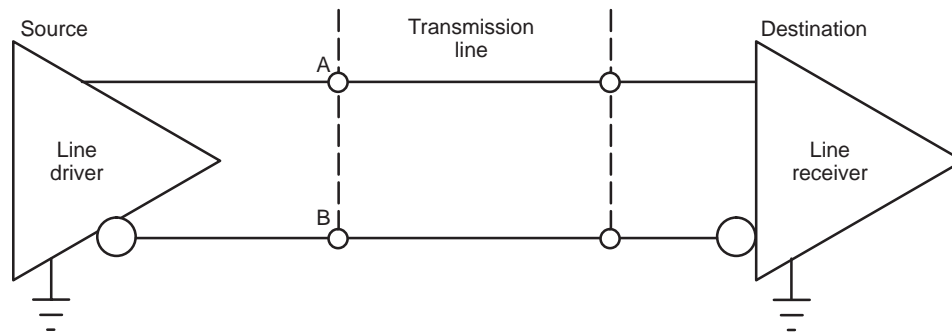

FIGURE 3 — Line driver and line receiver interconnection

## 4.2 Logic convention

The A terminal of the line driver is positive with respect to the B terminal for a binary 1 and a negative for a binary 0 (see Fig. 3).

## 4.3 Line driver characteristics (source)

4.3.1 Output impedance: 110  $\Omega$  maximum

4.3.2 Common mode voltage:  $-1.29 \text{ V} \pm 15\%$  (both terminals relative to ground).

4.3.3 Signal amplitude: 0.8 to 2.0 V peak-to-peak, measured across a 110  $\Omega$  resistive load.

4.3.4 Rise and fall times: less than 5 ns, measured between the 30% and 80% amplitude points, with a 110  $\Omega$  resistive load. The difference between rise and fall times must not exceed 2 ns.

## 4.4 Line receiver characteristics

4.4.1 Input impedance: 110  $\Omega \pm 10 \Omega$ .

4.4.2 Maximum input signal: 2.0 V peak-to-peak.

4.4.3 Minimum input signal: 185 mV peak-to-peak.

However, the line receiver must sense correctly the binary data when a random data signal produces the conditions represented by the eye diagram in Fig. 4 at the data detection point.

4.4.4 Maximum common mode signal:  $\pm 0.5 \text{ V}$ , comprising interference in the range 0 to 15 kHz (both terminals to ground).

4.4.5 Differential delay: Data must be correctly sensed when the clock-to-data differential delay is in the range between  $\pm 11 \text{ ns}$  (see Fig. 4).

## 5. Mechanical details of the connector

The interface uses the 25 contact type D subminiature connector specified in ISO Document 2110-1980, with contact assignment shown in Table V.

Connectors are locked together by a one-piece slide lock on the cable connectors and locking posts on the equipment connectors. Connectors employ pin contacts and equipment connectors employ socket contacts. Shielding of the interconnecting cable and its connectors must be employed (see Note).

*Note* — It should be noted that the ninth and eighteenth harmonics of the 13.5 MHz sampling frequency (nominal value) specified in Recommendation 601 fall at the 121.5 and 243 MHz aeronautical emergency channels. Appropriate precautions must therefore be taken in the design and operation of interfaces to ensure that no interference is caused at these frequencies. Emission levels for related equipment are given in CISPR Recommendation: "Information technology equipment – limits of interference and measuring methods" Document CISPR/B (Central Office) 16. Nevertheless, No. 964 of the Radio Regulations prohibits any harmful interference on the emergency frequencies.

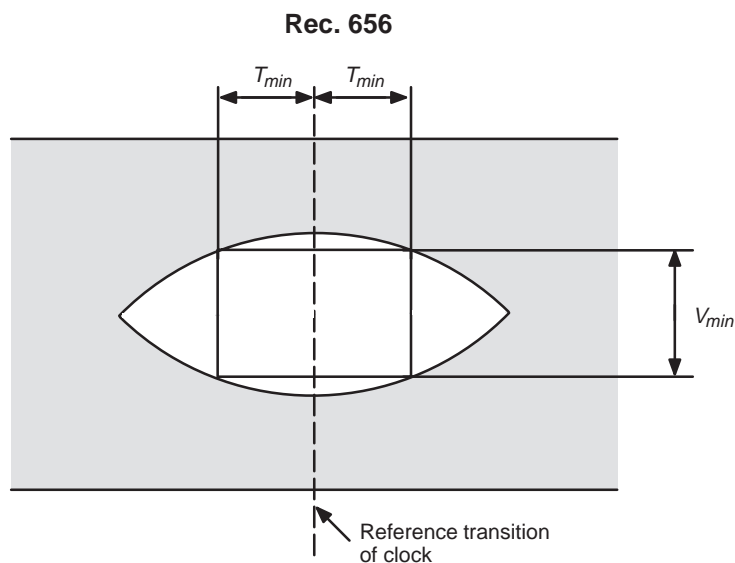

FIGURE 4 — Idealized eye diagram corresponding to the minimum input signal level

$$T_{min} = 11 \text{ ns}$$

$$V_{min} = 100 \text{ mV}$$

*Note* — The width of the window in the eye diagram, within which data must be correctly detected comprises  $\pm 3$  ns clock jitter,  $\pm 3$  ns data timing (see § 3.2), and  $\pm 5$  ns available for differences in delay between pairs of the cable.

TABLE V — Contact assignments

Contact	Signal line	Contact	Signal line
1	Clock A	14	Clock B
2	System ground	15	System ground
3	Data 7A (MSB)	16	Data 7B
4	Data 6A	17	Data 6B
5	Data 5A	18	Data 5B
6	Data 4A	19	Data 4B
7	Data 3A	20	Data 3B
8	Data 2A	21	Data 2B
9	Data 1A	22	Data 1B
10	Data 0A	23	Data 0B
11	Spare A-A	24	Spare A-B
12	Spare B-A	25	Spare B-B
13	Cable shield	—	—

## Rec. 656

Any spare pairs connected to contacts 11,24 or 12,25 are reserved for bits of lower significance than those carried on contacts 10,23.

## 6. Line receiver equalization

To permit correct operation with longer interconnection links, the line receiver may incorporate equalization.

When equalization is used, it should conform to the nominal characteristics of Fig. 5. This characteristic permits operation with a range of cable lengths down to zero. The line receiver must satisfy the maximum input signal condition of § 4.4

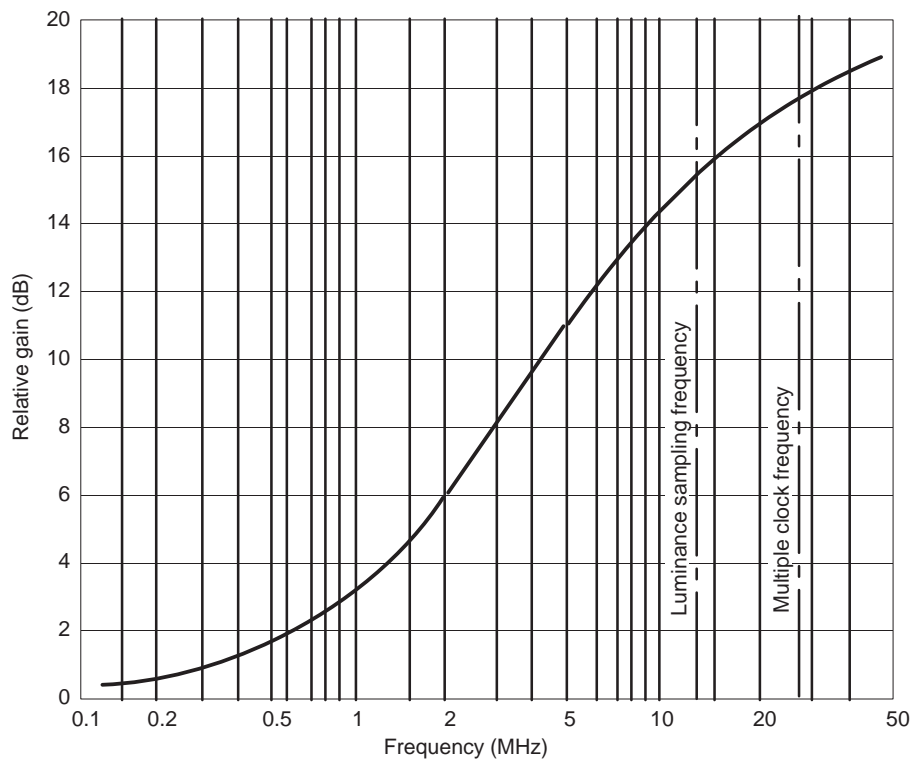

FIGURE 5 — Line receiver equalization characteristic for small signals

### PART III

#### BIT-SERIAL INTERFACE

##### 1. General description of the interface

The multiplexed data stream of 8-bit words (as described in Part I) is transmitted over a single channel in bit-serial form. Prior to transmission, additional coding takes place to provide spectral shaping, word synchronization and to facilitate clock recovery.

##### 2. Coding

The 8-bit data words are encoded for transmission into 9-bit words as shown in Table VI.

For some 8-bit data words alternative 9-bit transmission words exist, as shown in columns  $9B$  and  $\overline{9B}$ , each 9-bit word being the complement of the other. In such cases, the 9-bit word will be selected alternately from columns  $9B$  and  $\overline{9B}$  on each successive occasion that any such 8-bit word is conveyed. In the decoder, either word must be converted to the corresponding 8-bit data word.

## RECOMMENDATIONS OF THE CCIR, 1990

## CCIR 656

## Rec. 656

TABLE VI — Encoding table

Input	Output		Input	Output		Input	Output		Input	Output		Input	Output		Input	Output	
8B	9B	9B̄	8B	9B	9B̄	8B	9B	9B̄	8B	9B	9B̄	8B	9B	9B̄	8B	9B̄	9B̄
00	0FE	101	2B	053		56	097		81	0AA		AC	12C		D7	0CC	
01	027		2C	1AC		57	168		82	055		AD	0D9		D8	139	
02	1D8		2D	057		58	099		83	1AA		AE	126		D9	0CE	
03	033		2E	1A8		59	166		84	0D5		AF	0E5		DA	133	
04	1CC		2F	059		5A	09B		85	12A		B0	11A		DB	0D8	
05	037		30	1A6		5B	164		86	095		B1	0E9		DC	131	
06	1CB		31	05B		5C	09D		87	16A		B2	116		DD	0DC	
07	039		32	05D		5D	162		88	0B5		B3	02E		DE	127	
08	1C6		33	1A4		5E	0A3		89	14A		B4	1D1		DF	0E2	
09	03B		34	065		5F	15C		8A	09A		B5	036		E0	123	
0A	1C4		35	19A		60	0A7		8B	165		B6	1C9		E1	0E4	
0B	03D		36	069		61	158		8C	0A6		B7	03A		E2	11D	
0C	1C2		37	196		62	025	1DA	8D	159		B8	1C5		E3	0E6	
0D	14D		38	026	1D9	63	0A1	15E	8E	0AC		B9	04E		E4	11B	
0E	0B4		39	08C	173	64	029	1D6	8F	153		BA	1B1		E5	0E8	
0F	14B		3A	02C	1D3	65	091	16E	90	0AE		BB	05C		E6	119	
10	1A2		3B	098	167	66	045	1BA	91	151		BC	1A3		E7	0EC	
11	0B6		3C	032	1CD	67	089	176	92	02A	1D5	BD	05E		E8	117	
12	149		3D	0BE	141	68	049	1B6	93	092	16D	BE	1A1		E9	0F2	
13	0BA		3E	034	1CB	69	085	17A	94	04A	1B5	BF	066		EA	113	
14	145		3F	0C2	13D	6A	051	1AE	95	094	16B	C0	199		EB	0F4	
15	0CA		40	046	1B9	6B	08A	175	96	0A8	157	C1	06C		EC	10D	
16	135		41	0C4	13B	6C	0A4	15B	97	0B7	148	C2	193		ED	076	
17	0D2		42	04C	1B3	6D	054	1AB	98	0F5	10A	C3	06E		EE	10B	
18	12D		43	0C8	137	6E	0A2	15D	99	0BB	144	C4	191		EF	0C7	
19	0D4		44	058	1A7	6F	052	1AD	9A	0ED	112	C5	072		F0	13C	
1A	129		45	0B1		70	056		9B	0BD	142	C6	18D		F1	047	
1B	0D6		46	14E		71	1A9		9C	0EB	114	C7	074		F2	1B8	
1C	125		47	0B3		72	05A		9D	0D7	128	C8	18B		F3	067	
1D	0DA		48	14C		73	1A5		9E	0DD	122	C9	07A		F4	19C	
1E	115		49	0B9		74	06A		9F	0DB	124	CA	189		F5	071	
1F	0EA		4A	06B		75	195		A0	146		CB	08E		F6	198	
20	0B2		4B	194		76	096		A1	0C5		CC	185		F7	073	
21	02B		4C	06D		77	169		A2	13A		CD	09C		F8	18E	
22	1D4		4D	192		78	0A9		A3	0C9		CE	171		F9	079	
23	02D		4E	075		79	156		A4	136		CF	09E		FA	18C	
24	1D2		4F	18A		7A	0AB		A5	0CB		D0	163		FB	087	
25	035		50	08B		7B	154		A6	134		D1	0B8		FC	186	
26	1CA		51	174		7C	0A5		A7	0CD		D2	161		FD	0C3	
27	04B		52	08D		7D	15A		A8	132		D3	0BC		FE	178	
28	1B4		53	172		7E	0AD		A9	0D1		D4	147		FF	062	19D
29	04D		54	093		7F	152		AA	12E		D5	0C6				
2A	1B2		55	16C		80	155		AB	0D3		D6	143				

## Rec. 656

**3. Order of transmission**

The least significant bit of each 9-bit word shall be transmitted first.

**4. Logic convention**

The signal is conveyed in NRZ form. The voltage at the output terminal of the line driver shall increase on a transition from 0 to 1 (positive logic).

**5. Transmission medium**

The bit-serial data stream can be conveyed using either a coaxial cable (§ 6) or fibre optic bearer (§ 7).

**6. Characteristics of the electrical interface****6.1 Line driver characteristics (source)****6.1.1 Output impedance**

The line driver has an unbalanced output with a source impedance of 75  $\Omega$  and a return loss of at least 15 dB over a frequency range of 10 to 243 MHz.

**6.1.2 Signal impedance**

The peak-to-peak signal amplitude lies between 400 mV and 700 mV measured across a 75  $\Omega$  resistive load directly connected to the output terminals without any transmission line.

**6.1.3 DC offset**

The DC offset with reference to the mid amplitude point of the signal lies between +1.0V and -1.0 V.

**6.1.4 Rise and fall times**

The rise and fall times, determined between the 20% and 80% amplitude points and measured across a 75  $\Omega$  resistive load connected directly to the output terminals, shall lie between 0.75 and 1.5 ns and shall not differ by more than 0.40 ns.

**6.1.5 Jitter**

The timing of the rising edges of the data signal shall be within  $\pm 0.10$  ns of the average timing of rising edges, as determined over a period of one line.

**6.2 Line receiver characteristics (destination)****6.2.1 Terminating impedance**

The cable is terminated by 75  $\Omega$  with a return loss of at least 15 dB over a frequency range of 10 to 243 MHz.

**6.2.2 Receiver sensitivity**

The line receiver must sense correctly random binary data either when connected directly to a line driver operating at the extreme voltage limits permitted by § 6.1.2, or when connected via a cable having loss of 40 dB at 243 MHz and a loss characteristic of  $1/\sqrt{f}$ .

Over the range 0 to 12 dB no equalization adjustment is required; beyond this range adjustment is permitted.

**6.2.3 Interference rejection**

When connected directly to a line driver operating at the lower limit specified in § 6.1.2, the line receiver must correctly sense the binary data in the presence of a superimposed interfering signal at the following levels:

d.c.	$\pm 2.5$ V
Below 1 kHz:	2.5 V peak-to-peak
1 kHz to 5 MHz:	100 mV peak-to-peak
Above 5 MHz:	40 mV peak-to-peak

---

**Rec. 656****6.3** *Cables and connectors***6.3.1** *Cable*

It is recommended that the cable chosen should meet any relevant national standards on electro-magnetic radiation.

*Note* — It should be noted that the ninth and eighteenth harmonics of the 13.5 MHz sampling frequency (nominal value) specified in Recommendation 601 fall at the 121.5 and 243 MHz aeronautical emergency channels. Appropriate precautions must therefore be taken in the design and operation of interfaces to ensure that no interference is caused at these frequencies. Emission levels for related equipment are given in CISPR Recommendation: "Information technology equipment – limits of interference and measuring methods" (Document CISPR/B (Central Office) 16). Nevertheless, No. 964 of the Radio Regulations prohibits any harmful interference on the emergency frequencies.

**6.3.2** *Characteristic impedance*

The cable used shall have a nominal characteristic impedance of 75  $\Omega$ .

**6.3.3** *Connector characteristics*

The connector shall have mechanical characteristics conforming to the standard BNC type (IEC Publication 169-8), and its electrical characteristics should permit it to be used at frequencies up to 500 MHz in 75  $\Omega$  circuits.

**7. Characteristics**

To be defined.

---