

DB25M (针)

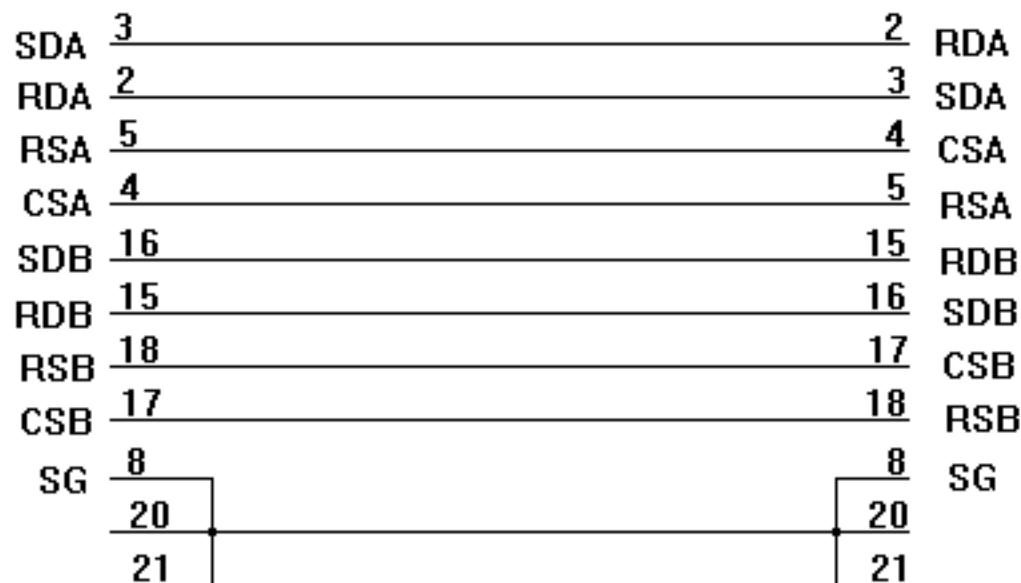

DB25M (针)

FX2 and A CPU ⇐

⇐ A970GOT

FX2、A系列PLC到A970GOT人机介面连接电缆。

型号 AC30R4-25P

DB9(孔)

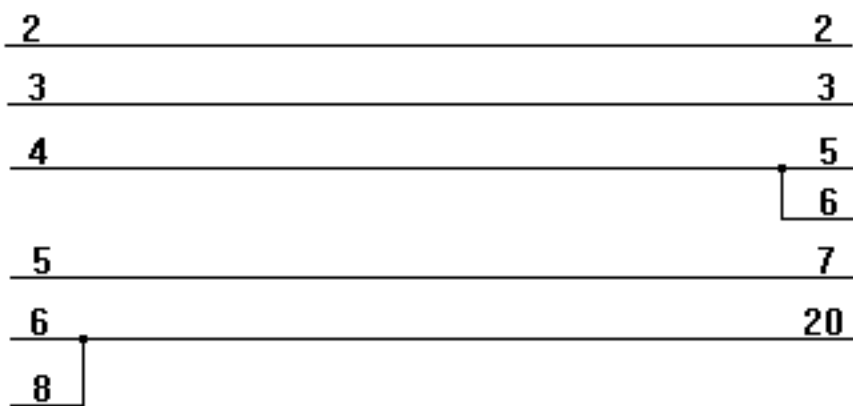

DB25(针)

接电脑的  
RS232口

DB9(孔)

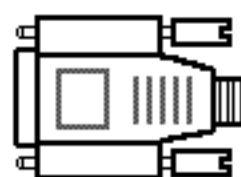

DB25(针)

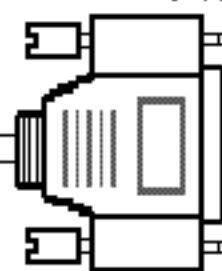

计算机到FX-232AW/FXON-232ADP/50DU6连接电缆。

型号

F2-232CAB-1

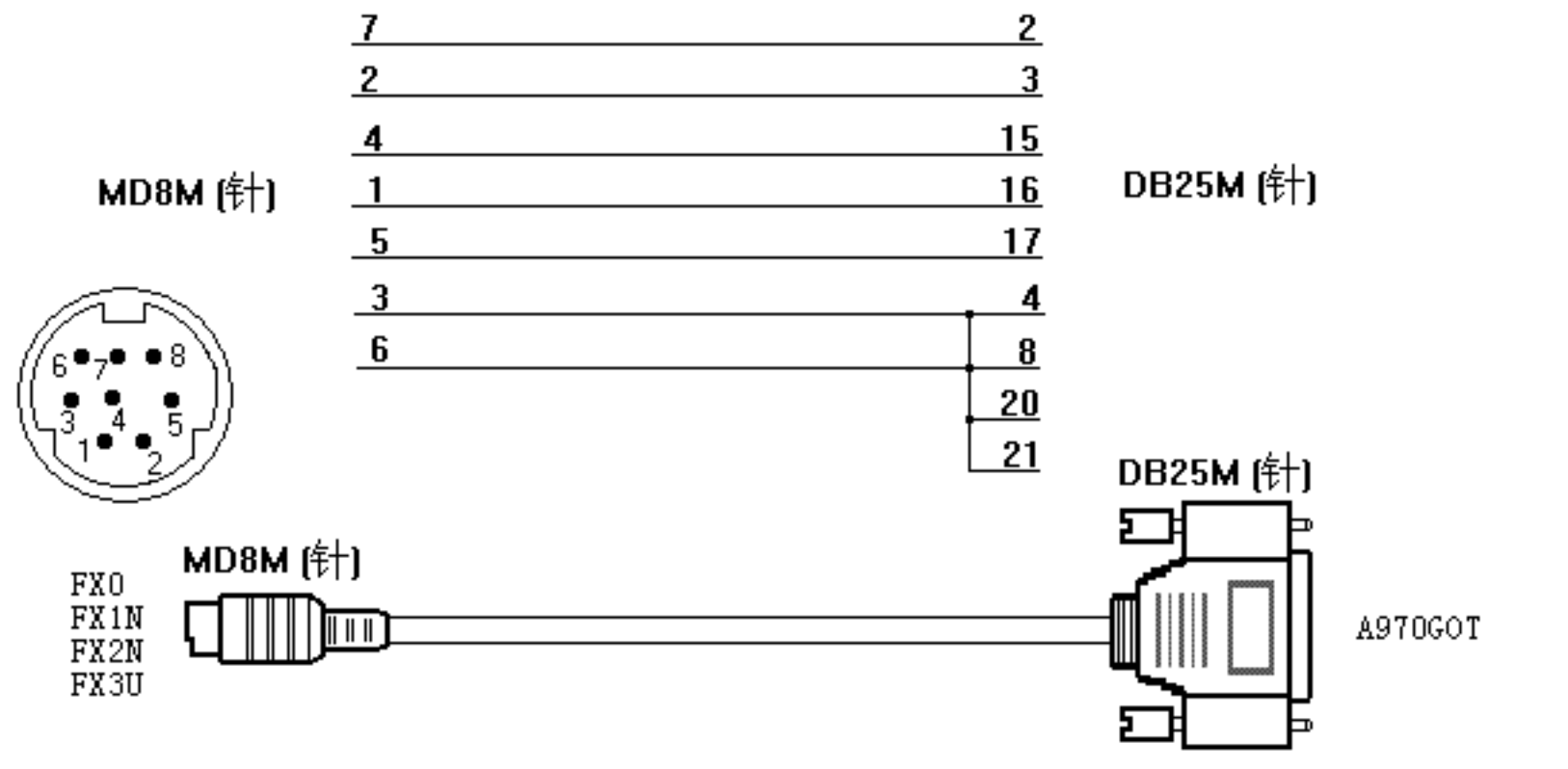

FX0s/FX0n/FX2n/FX1n等PLC到A970GOT人机介面连接电缆。

型号 FX9GT-CAB0

MD8M (针)

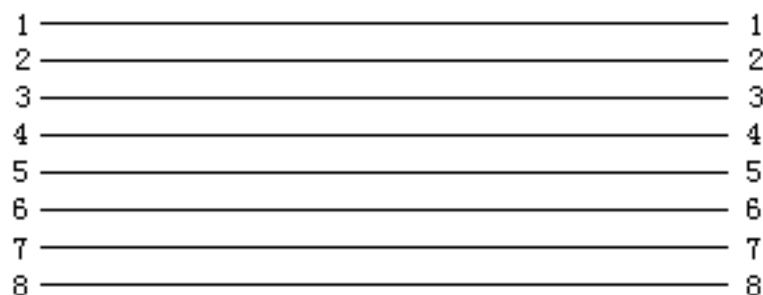

MD8M (针)

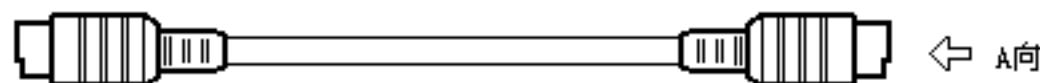

三菱 FX-20P-E 手持编程器到 FX0/FX2n/FX1n 等系列 PLC 连接电缆。

型号 FX-20P-CAB0

MD8M(针)

|   |    |
|---|----|
| 1 | 15 |
| 2 | 2  |
| 3 | 7  |
| 4 | 16 |
| 5 | 12 |
| 6 | 20 |
| 7 | 3  |
| 8 | 24 |

DB25M(针)

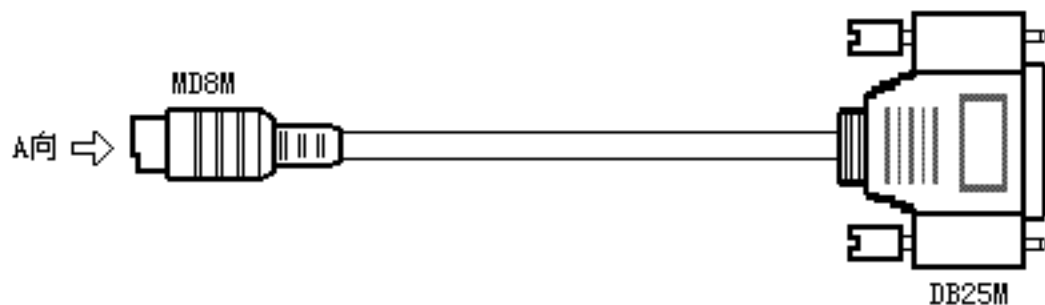
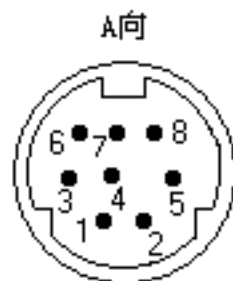
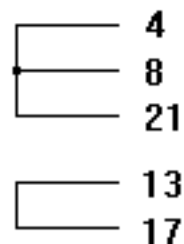

三菱 FX-20P-E 手持编程器到 FX2/FX2C 系列 PLC 连接电缆。

型号 FX-20P-CAB

MD8M (针)

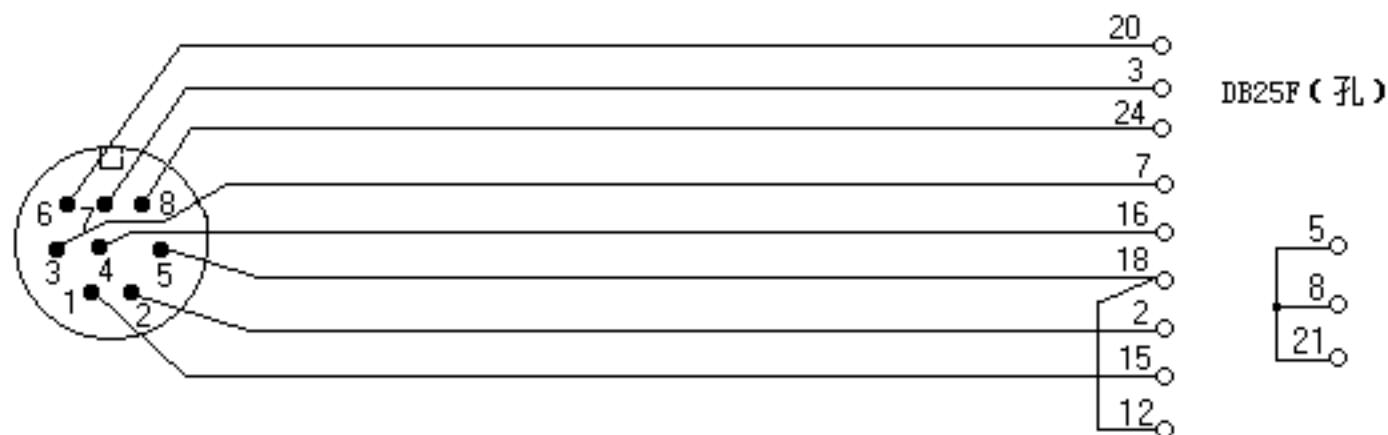

MD8M (针)

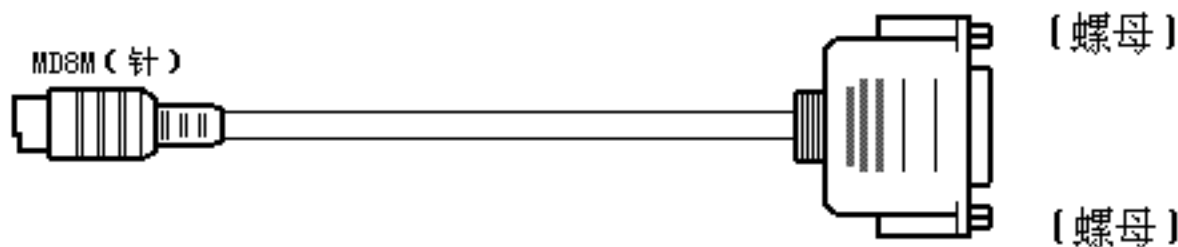

三菱FX0/FX2n/FX1n等系列PLC通用适配电缆。

型号

FX-20P-CADP

DB25M (针)

8  
21



DB9M(针)

DB25M (针)

FX2  
FX2C  
A

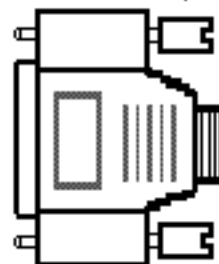

DB9M(针)

F940  
F930  
F920

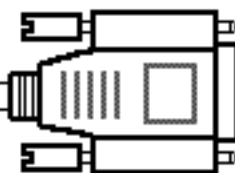

三菱FX2/A系列PLC同人机介面F940/F930/F920相连电缆

型号

FX-40DU-CAB

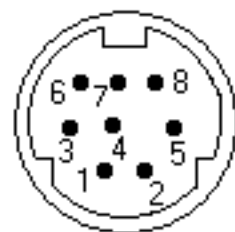

MD8M(针)

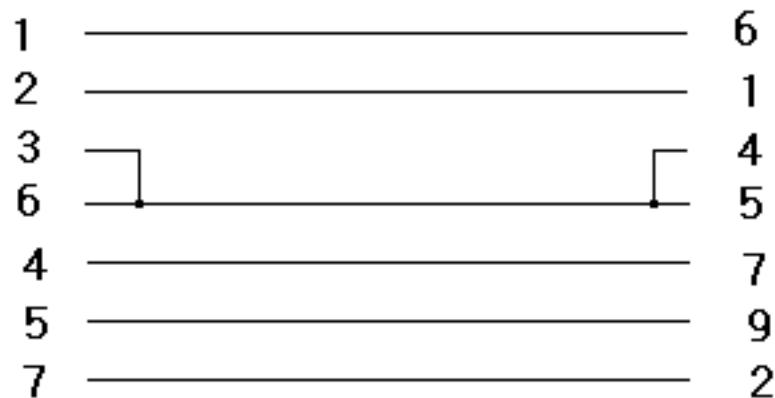

DB9M(针)

FX0  
FX1N  
FX2N  
FX3U

MD8M(针)



DB9M(针)

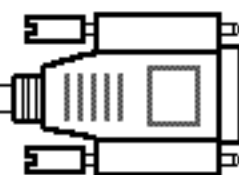

F940  
F930  
F920

三菱FX0/FX2n系列PLC同人机介面F940/F930/F920相连电缆

型号

FX-50DU-CAB0



DB9F(孔)

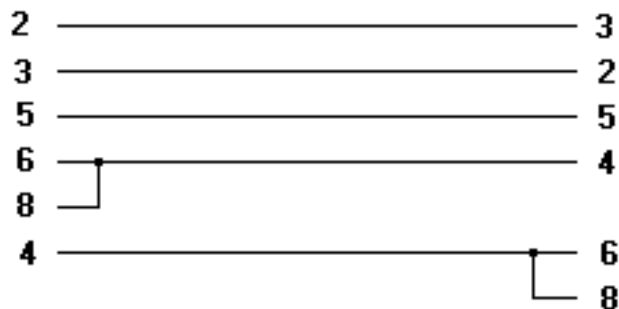

DB9F(孔)

DB9F(孔)

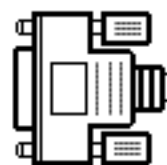

DB9F(孔)



计算机到三菱F940/930/920触摸屏编程电缆

型号

FX-232CAB-1

MD8M (针)

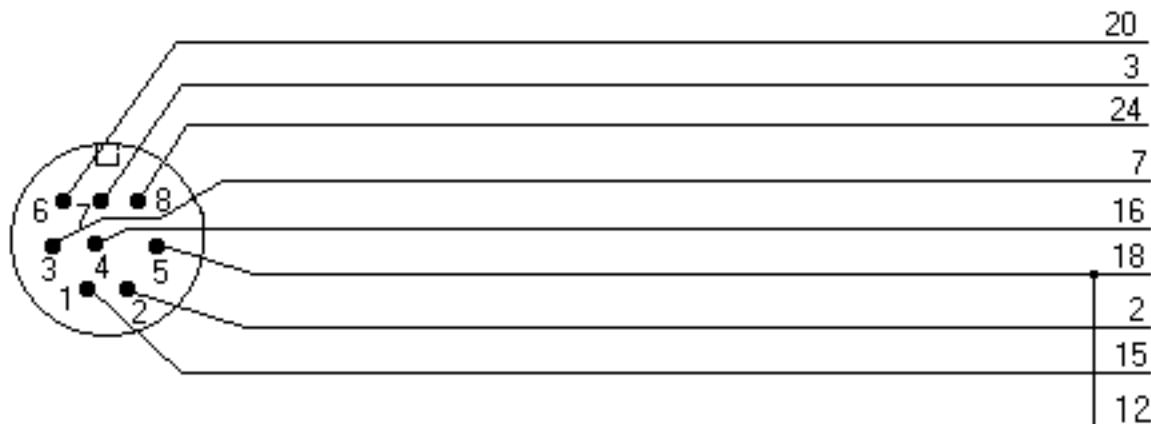

DB25M (针)

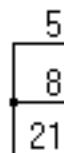

MD8M (针)



DB25M (针)

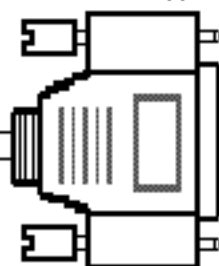

FX-232AW与FX2N/FX1N/FX0N/FX1S/FX0等连接电缆。

型号

FX-422CAB0

MD6M (针)

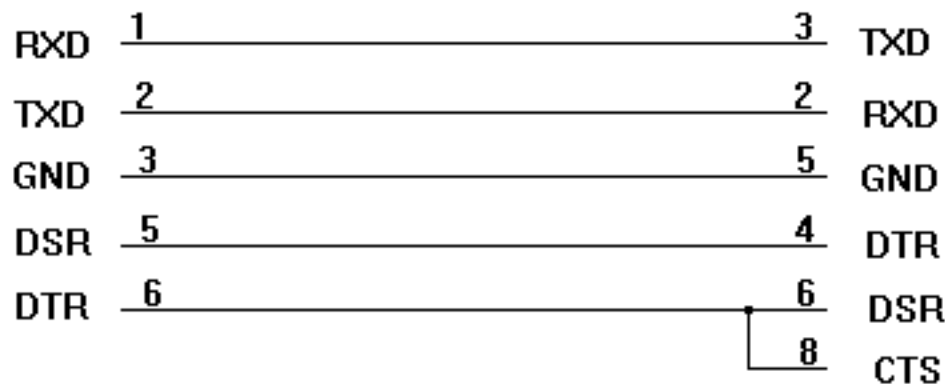

DB9F (孔)

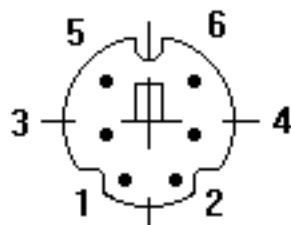

MD6M



DB9F

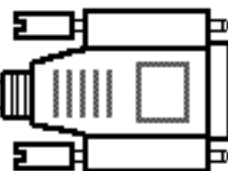

GT11/GT15触摸屏  
RS232口

三菱Q系列PLC ←

三菱GT11/GT15触摸屏连接Q系列PLC电缆

型号 GT01-C30R2-6P

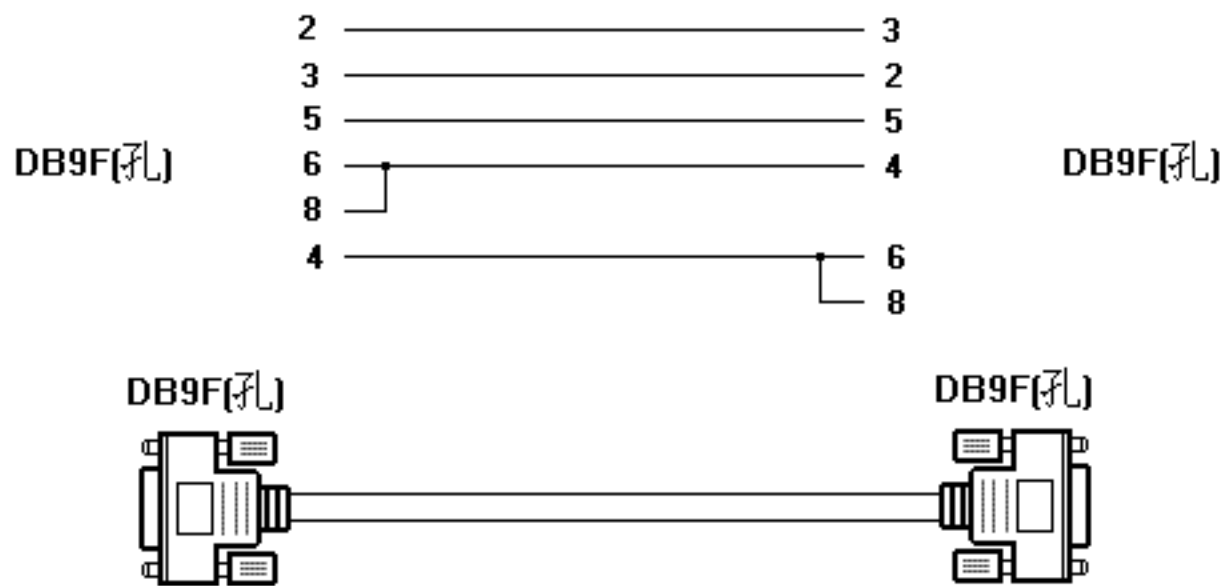

三菱GT11/GT15触摸屏串口编程电缆(连接电脑RS232串口)

|    |               |
|----|---------------|
| 型号 | GT01-C30R2-9S |
|----|---------------|



MD8M(针)

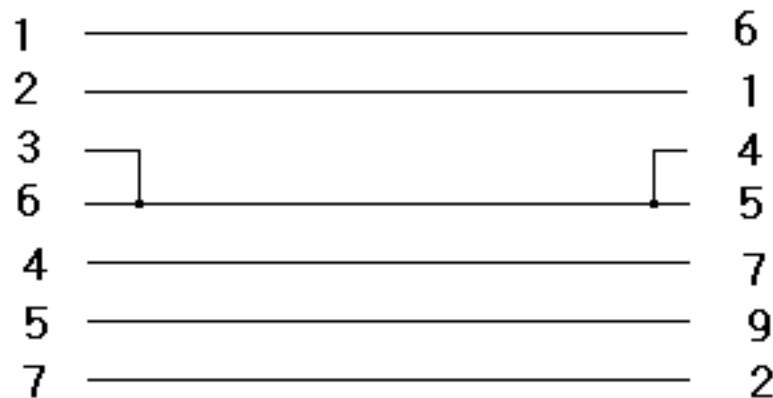

DB9M(针)

FX0  
FX1N  
FX2N  
FX3U  
RS422□

MD8M(针)



DB9M(针)

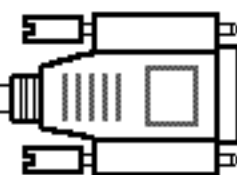

GT11/GT15  
触摸屏的  
RS422□

三菱GT11/GT15触摸屏连接三菱FX3U/FX2N/FX1N电缆

型号 GT01-C30R4-8P

DB25M (针)



DB9M(针)

DB25M (针)

FX2  
FX2C  
A  
QnA

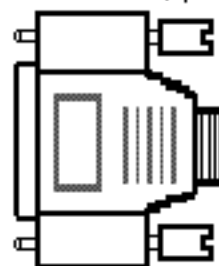

8  
21

DB9M(针)

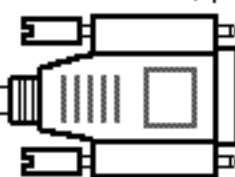

GT11/GT15  
触摸屏的  
RS422口

三菱GT11/GT15触摸屏连接FX2/FX2C/A/QnA系列PLC电缆

型号

GT01-C30R4-25P

MD6M (针)

|     |   |   |     |
|-----|---|---|-----|
| RXD | 1 | 3 | TXD |
| TXD | 2 | 2 | RXD |
| GND | 3 | 5 | GND |
| DSR | 5 | 4 | DTR |
| DTR | 6 | 6 | DSR |
|     |   | 8 | CTS |

DB9F (孔)

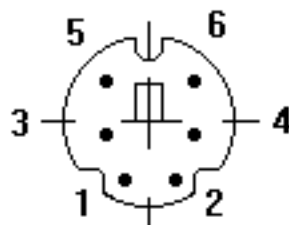

MD6M

DB9F

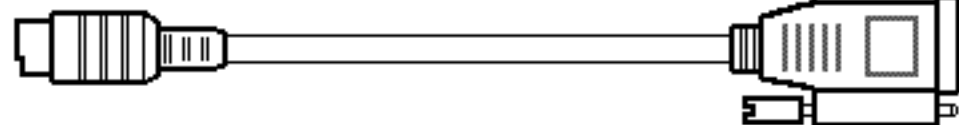

计算机

三菱Q系列PLC ←

RS232接口的三菱Q系列PLC编程通讯电缆

型号

QC30R2

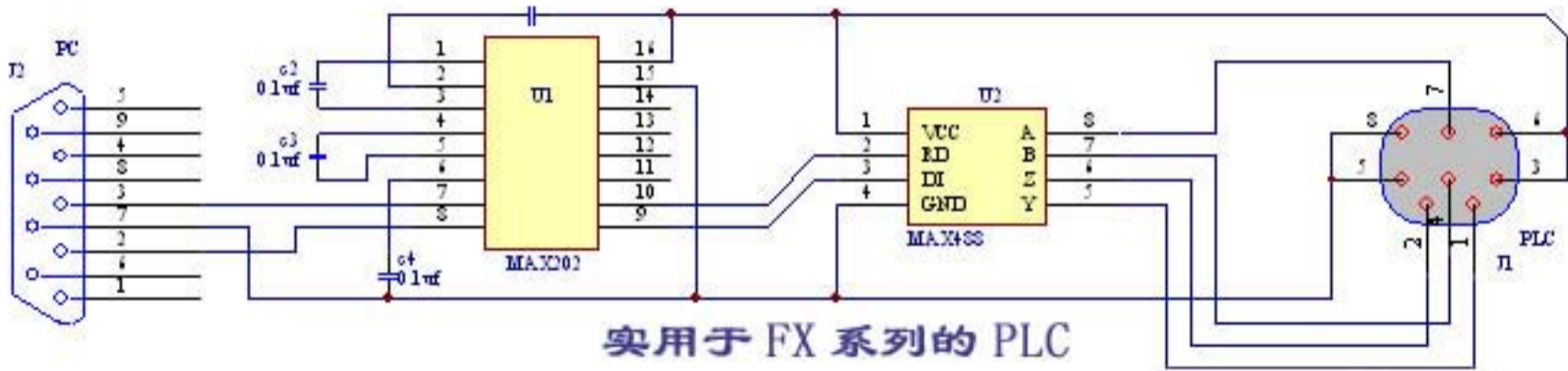



欧姆龙CQM1、CPM1、CPM1A、CPM2A、CPM2AH、C200HS、C200HX/HG/HE和SRM1系列PLC的外设口与欧姆龙触摸屏的RS232端口的连接需使用FS-CIF02 编程电缆，在FS-CIF02的RS232插头和欧姆龙触摸屏的RS232端口之间需按下图自制一个转接头。

用户也可在购买FS-CIF02电缆时要求厂家做成直接连欧姆龙触摸屏的形式，这样一来就省去了自制转接头的麻烦。

CQM1  
CPM1  
CPM1A  
CPM2A  
CPM2AH  
C200HS  
C200HX/HG/HE  
SRM1

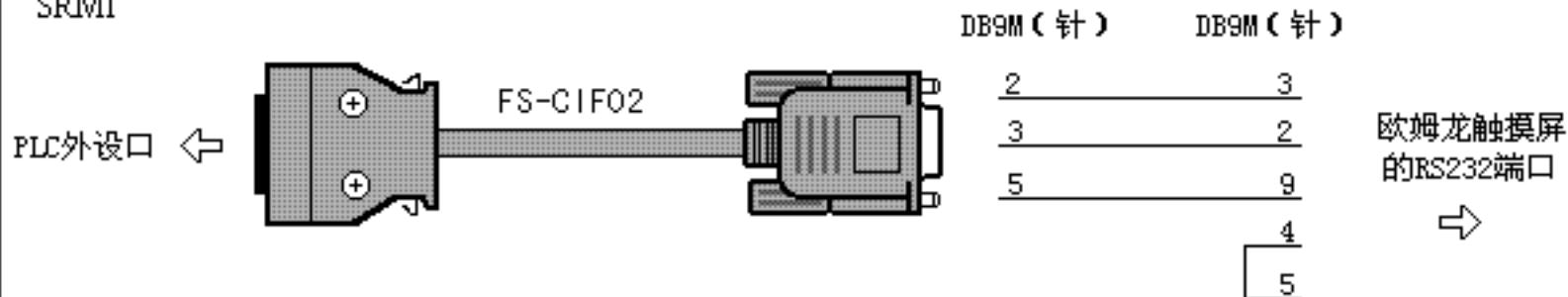

欧姆龙PLC的外设口与欧姆龙触摸屏的RS232端口的连接

型 号 FS-CIF02-HMI

欧姆龙CQM1H、CS/CJ、CPM2C系列PLC的外设口与欧姆龙触摸屏的RS232端口的连接需使用FS-CN226编程电缆，在FS-CN226的RS232插头和欧姆龙触摸屏的RS232端口之间需按下图自制一个转接头

用户也可在购买FS-CN226电缆时要求厂家做成直接连欧姆龙触摸屏的形式，这样一来就省去了自制转接头的麻烦。

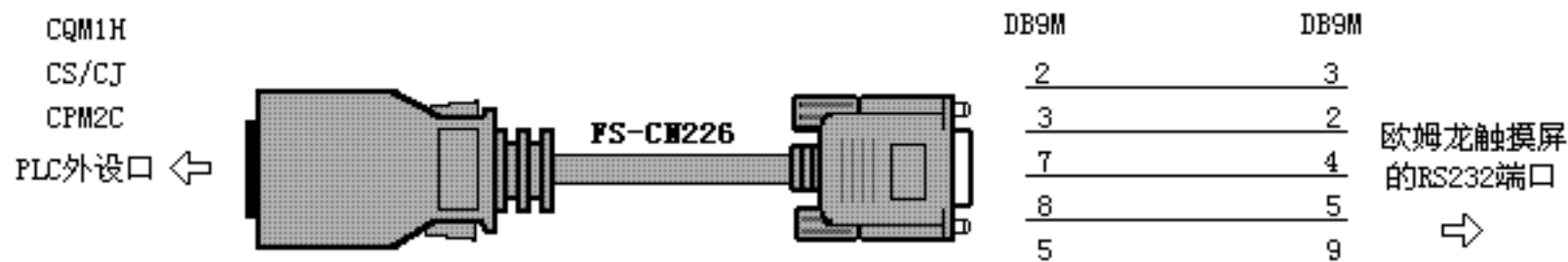

欧姆龙CQM1H、CS/CJ、CPM2C系列PLC的外设口与欧姆龙触摸屏的RS232端口的连接

型号 FS-CN226-HMI

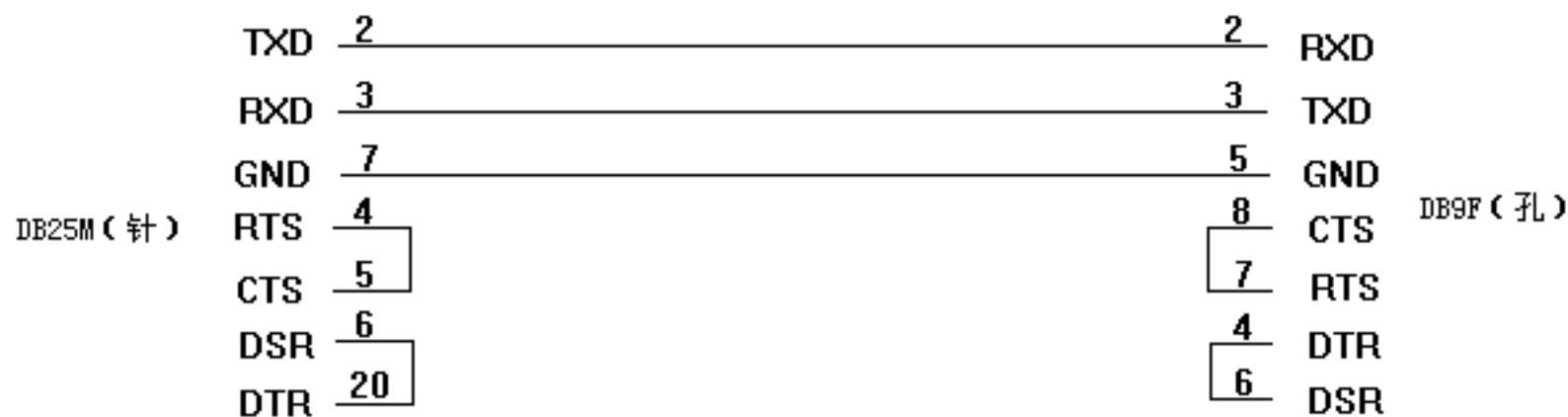

计算机的RS232口 (DB9M) 与 C200H、C60P、C1000H、CVM1 连 LK201 (DB25F) 编程电缆, 最大长度不能超过30米。  
LK201上DIP设置: 1, 2-不用 3-ON 4-OFF SW1-0 SW2-0 SW3-5 SW4-2

型号 XW2Z-200P-V

DB9M (针)

|     |   |   |     |
|-----|---|---|-----|
| TXD | 2 | 2 | RXD |
| RXD | 3 | 3 | TXD |
| GND | 9 | 5 | GND |
| RTS | 4 | 7 | RTS |
| CTS | 5 | 8 | CTS |
|     |   | 4 | DTR |
|     |   | 6 | DSR |

DB9F (孔)

欧姆龙PLC  
的RS232口

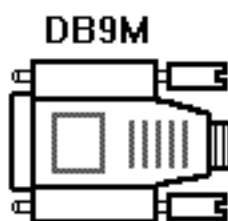

DB9M

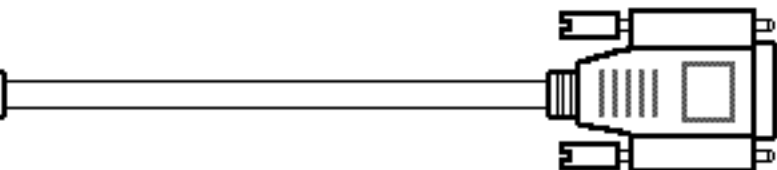

DB9F



计算机RS232口

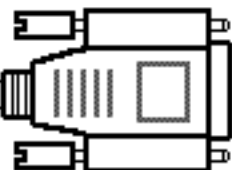

超过30米或需多点通信时，需采用FS-485C或FS-485GT转换成RS485通信！

计算机的RS232口 (DB9M) 与欧姆龙PLC 的RS232口 (DB9F) 之连接电缆，最大长度不能超过30米。

型号

XW2Z-200S

|          |     |   |   |     |          |
|----------|-----|---|---|-----|----------|
| DB9M (针) | TXD | 2 | 3 | RXD | DB9M (针) |
|          | RXD | 3 | 2 | TXD |          |
|          | RTS | 4 | 4 | CTS |          |
|          | CTS | 5 | 5 | RTS |          |
|          | GND | 9 | 9 | GND |          |

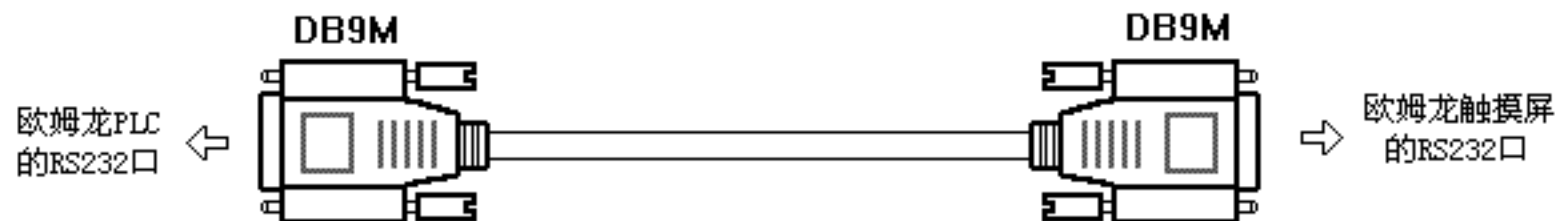

超过30米或需多点通信时，需采用FS-485C或FS-485GT转换成RS485通信！

欧姆龙PLC的RS232口（DB9F）与欧姆龙触摸屏的RS232口（DB9F）之连接电缆，最大长度不超过30米。超过30米时需使用FS-485C或FS-485GT转换器转换成RS485通信。

|    |           |
|----|-----------|
| 型号 | XW2Z-200T |
|----|-----------|

|          |     |   |     |     |          |
|----------|-----|---|-----|-----|----------|
| DB9M (针) | TXD | 2 | 2   | RXD | DB9F (孔) |
|          | RXD | 3 | 3   | TXD |          |
|          | RTS | 4 | 8   | CTS |          |
|          | CTS | 5 | 7   | RTS |          |
|          | GND | 9 | 5   | GND |          |
|          |     |   | 4   | DTR |          |
|          |     | 6 | DSR |     |          |

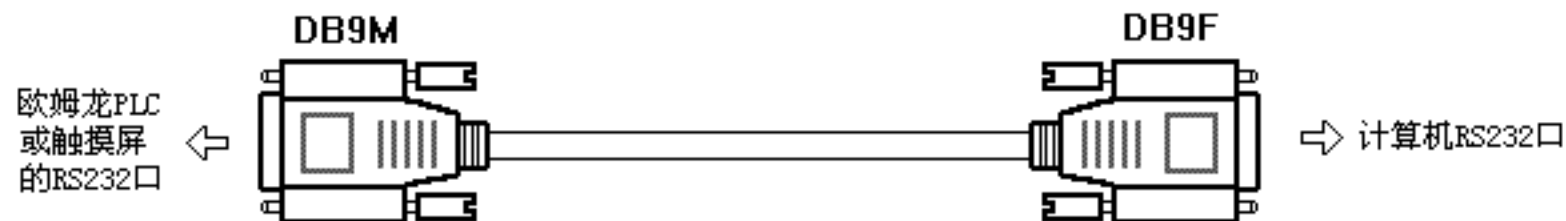

超过30米或需多点通信时，需采用FS-485C或FS-485GT转换成RS485通信！

计算机的RS232口（DB9M）与欧姆龙PLC和欧姆龙触摸屏的RS232口（DB9F）之连接电缆，最大长度不能超过30米。也可用于欧姆龙PLC或触摸屏的RS232口与德阳四星电子的FS-485C、FS-485G、FS-485GT、FS-485E转换器的连接。

型号 XW2Z-S002

MD5M(针)

1 ————— 5  
2 ————— 2  
3 ————— 3

DB9(孔)

7  
8  
6  
1  
4

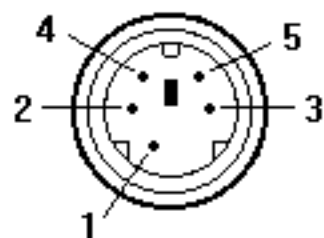

MD5M(针)



DB9(孔)

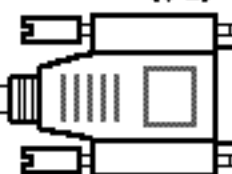

松下PLC计算机编程电缆，连接计算机和FP0、FP2、FP-M系列PLC

型号 AFC8513 或 SH8513

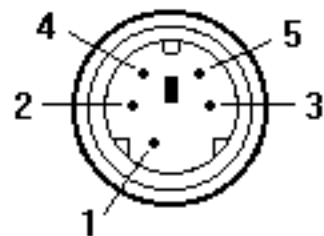
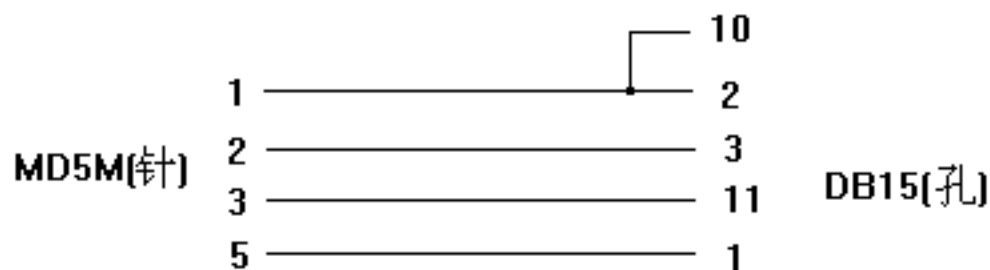

MD5M(针)

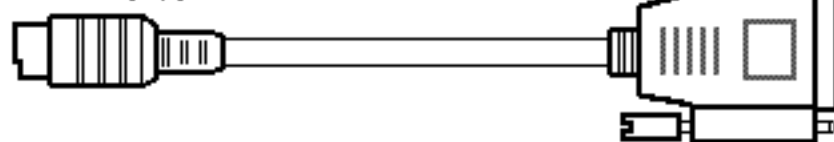

DB15(孔)

松下PLC手编器电缆，连接手持编程器和 FP0、FP2、FP-M系列PLC

型号    AFC8523 或 SH8523



插头型号：HR212-10LP-8P

|   |       |    |
|---|-------|----|
| 1 | ————— | 2  |
| 2 | ————— | 6  |
| 3 | ————— | 7  |
| 5 | ————— | 14 |
| 6 | ————— | 15 |
| 7 | ————— | 3  |
| 8 | ————— | 1  |

|   |    |
|---|----|
| □ | 4  |
| □ | 5  |
| □ | 12 |
| □ | 13 |

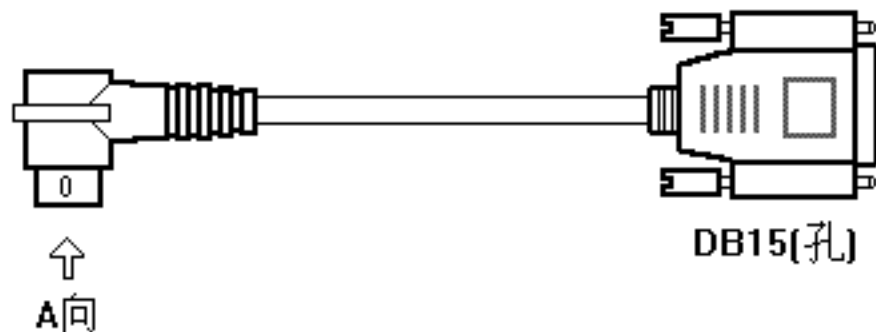
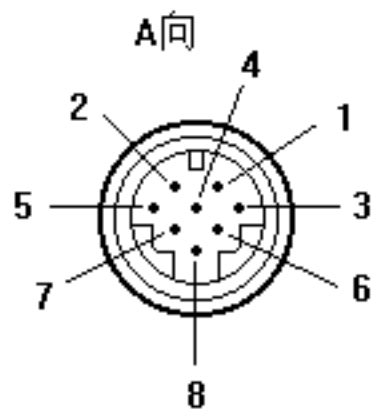

松下FP1系列PLC到AFP8550适配器或手持编程器连接电缆

型号 AFP1523 或 SH1523

DB15(孔)



DB15(针)

DB15(孔)

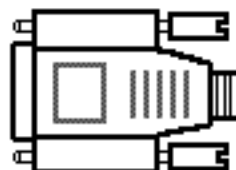

AFP8550

DB15(针)

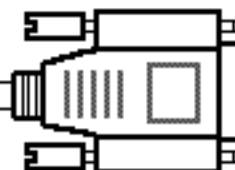

FP3  
FP5

松下FP3、FP5系列PLC到AFP8550适配器或手持编程器连接电缆

型号

AFP5523 或 SH5523

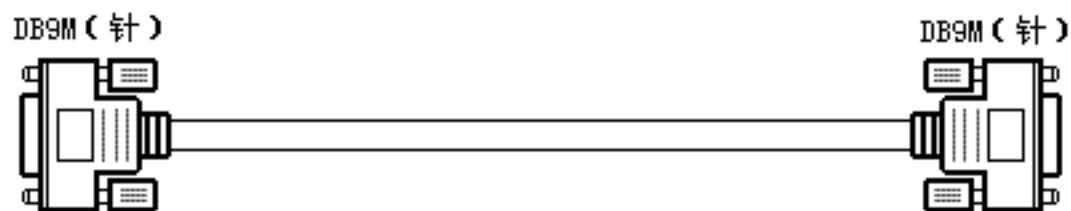
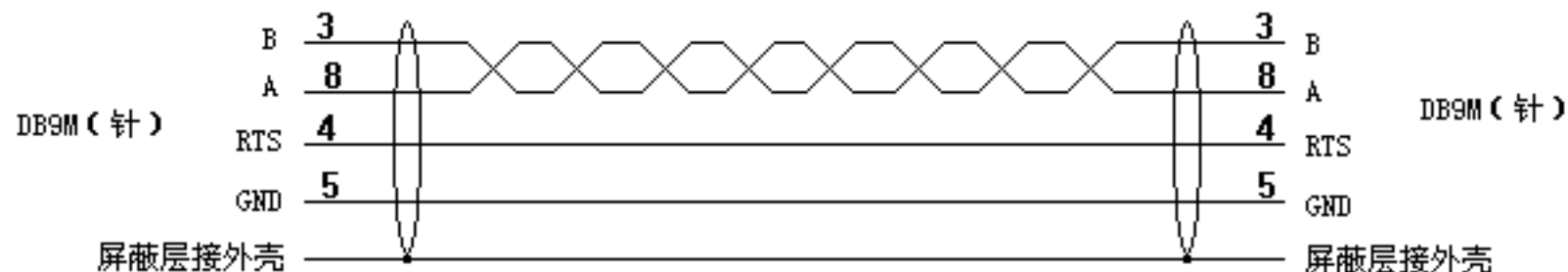

ST-200/300 PLC到西门子触摸屏连接电缆，对应西门子产品号：6ES7 901-0BF00-0AA0

|    |       |
|----|-------|
| 型号 | MPI电缆 |
|----|-------|

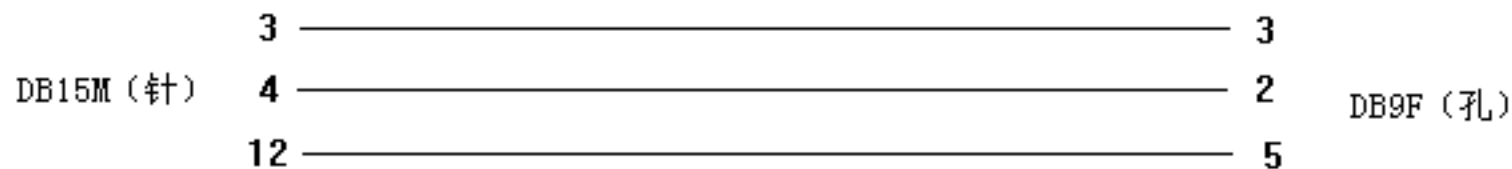

OP人机介面 ←

→ 电脑

西门子OP触摸屏编程电缆，对应西门子产品号：6XV1 440-2KH32

|    |        |
|----|--------|
| 型号 | OP编程电缆 |
|----|--------|

DB9F (孔)

|   |   |
|---|---|
| 2 | 3 |
| 3 | 2 |
| 4 | 6 |
| 5 | 5 |
| 6 | 4 |
| 7 | 8 |
| 8 | 7 |

DB9F (孔)

DB9F (孔)

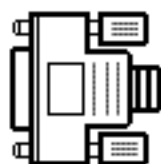

DB9F (孔)



PC/MPI适配器用RS232电缆，对应西门子产品号:6ES7901-1BF00-0XA0

型号

RS232电缆